

MEHRSHAHR APARTMENT



February 2026

CONTENTS

DESIGN PROCESS 04

PLANS 26

EXTERIOR VIEWS 35

Design Process



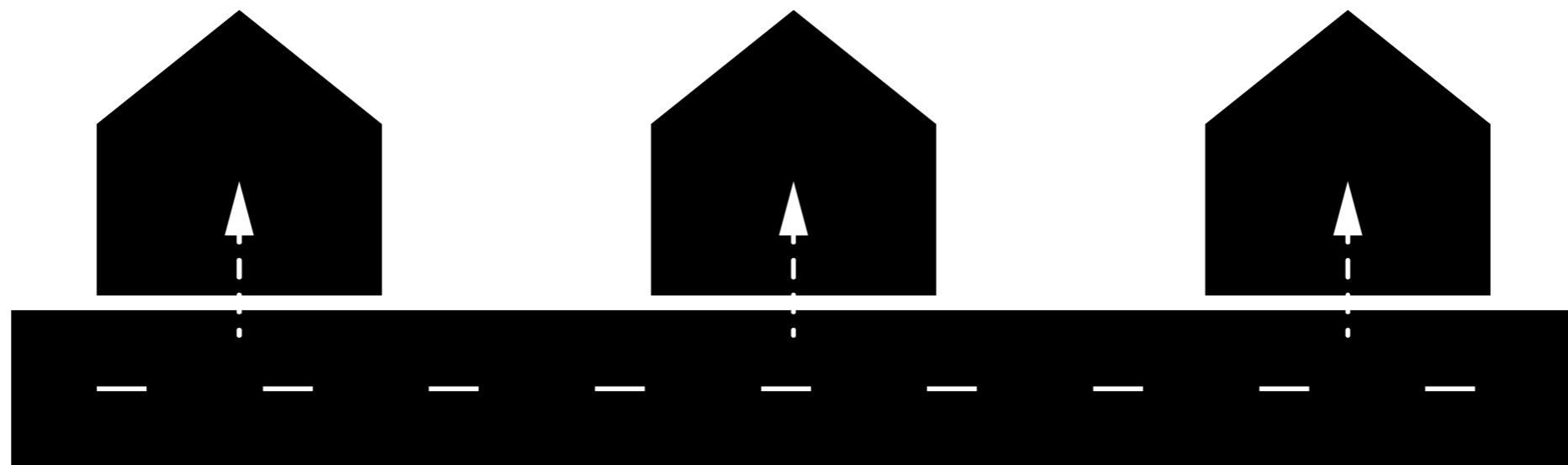

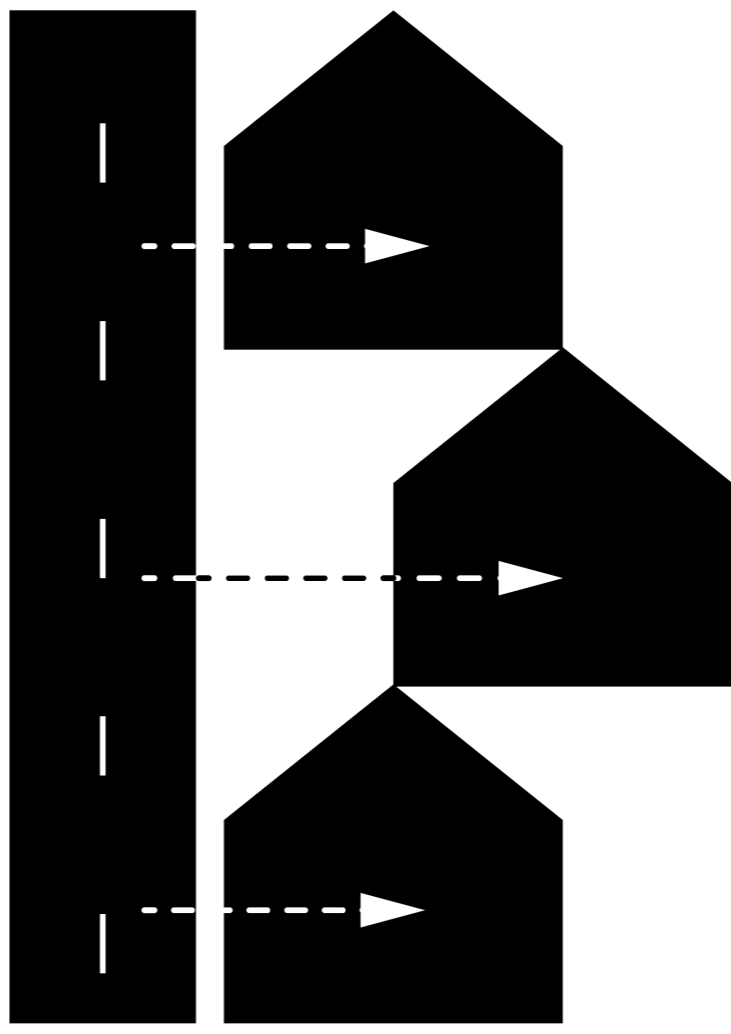

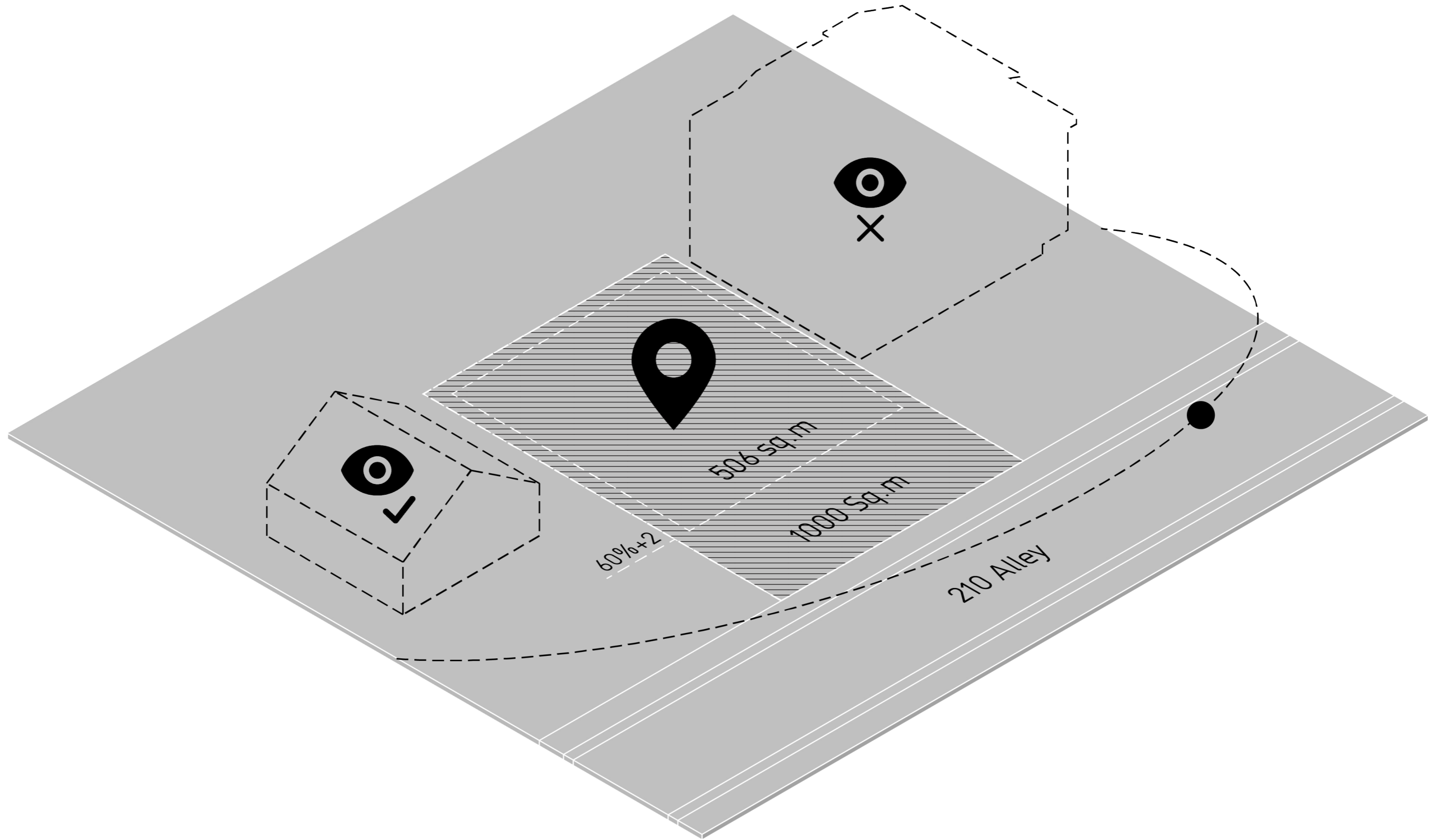

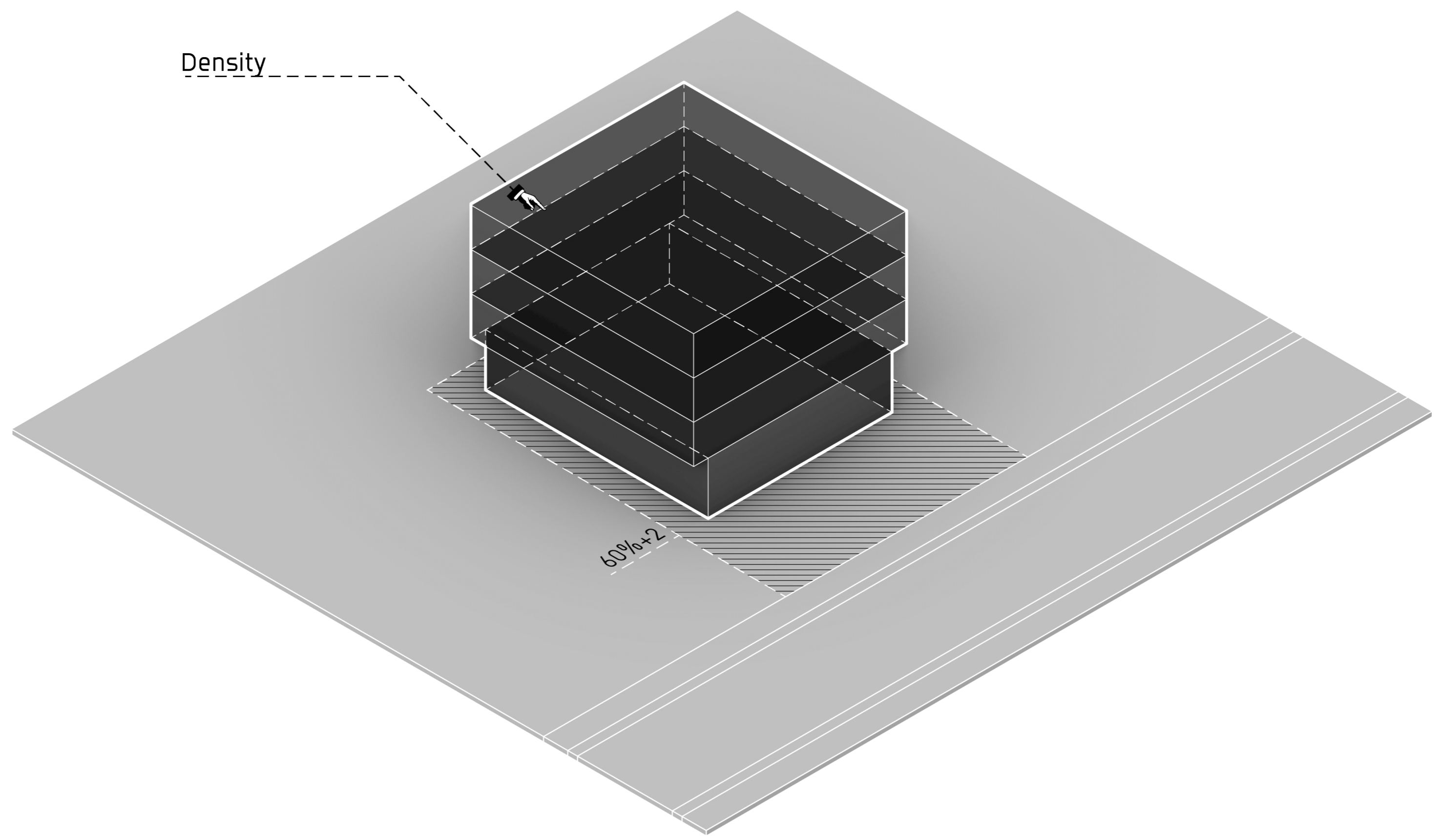

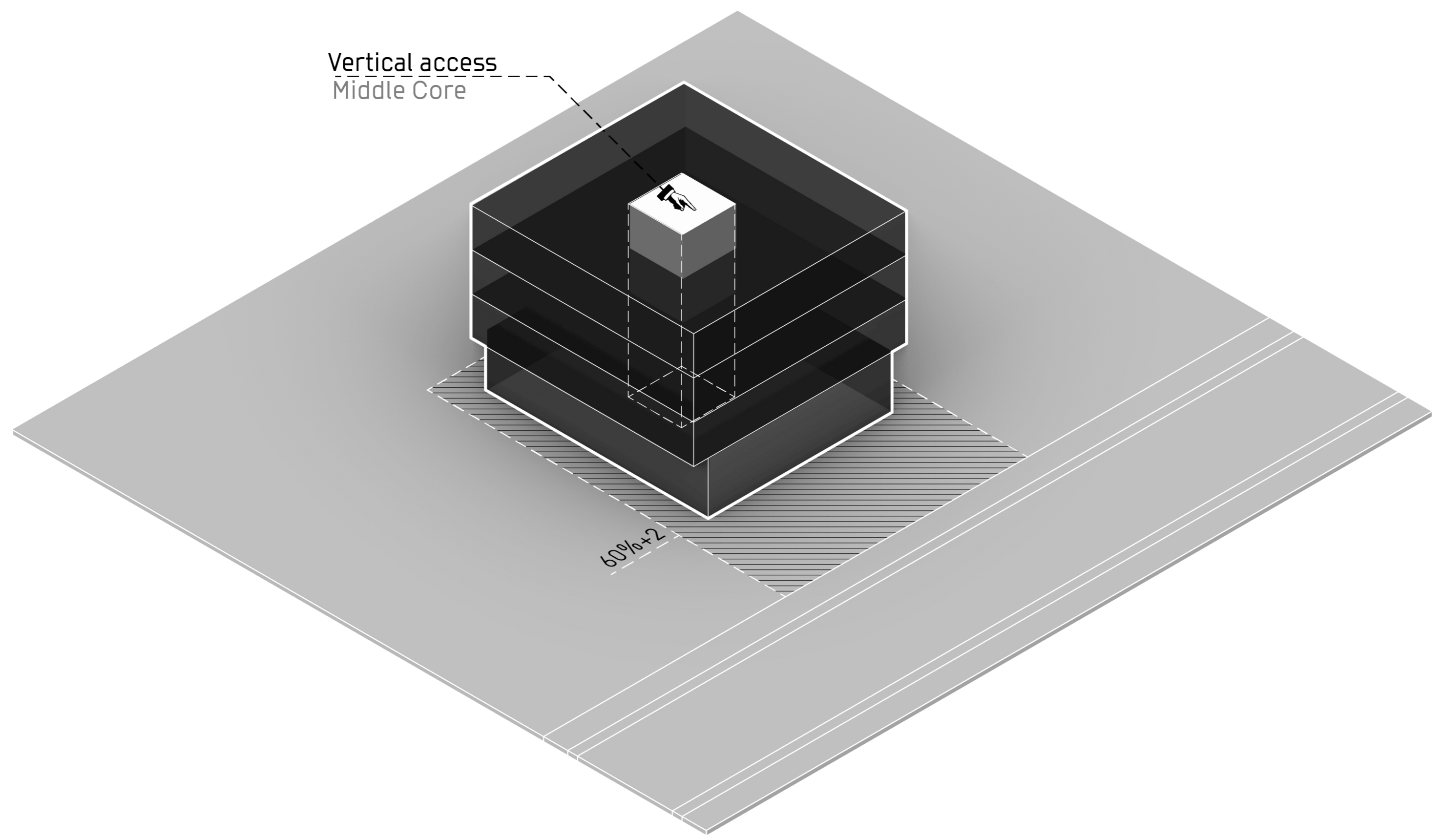

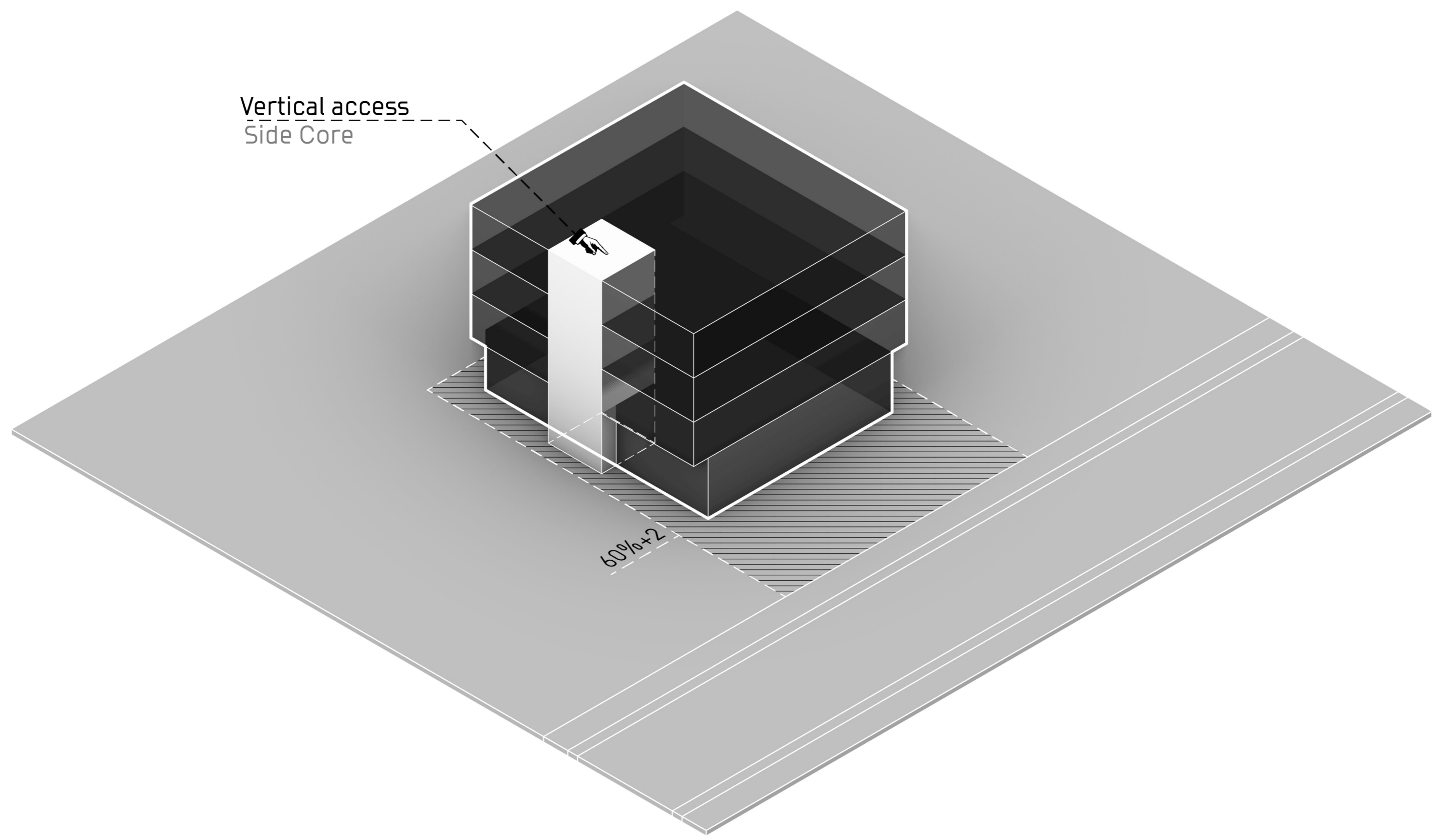

Vertical access
Side Core

60%+2

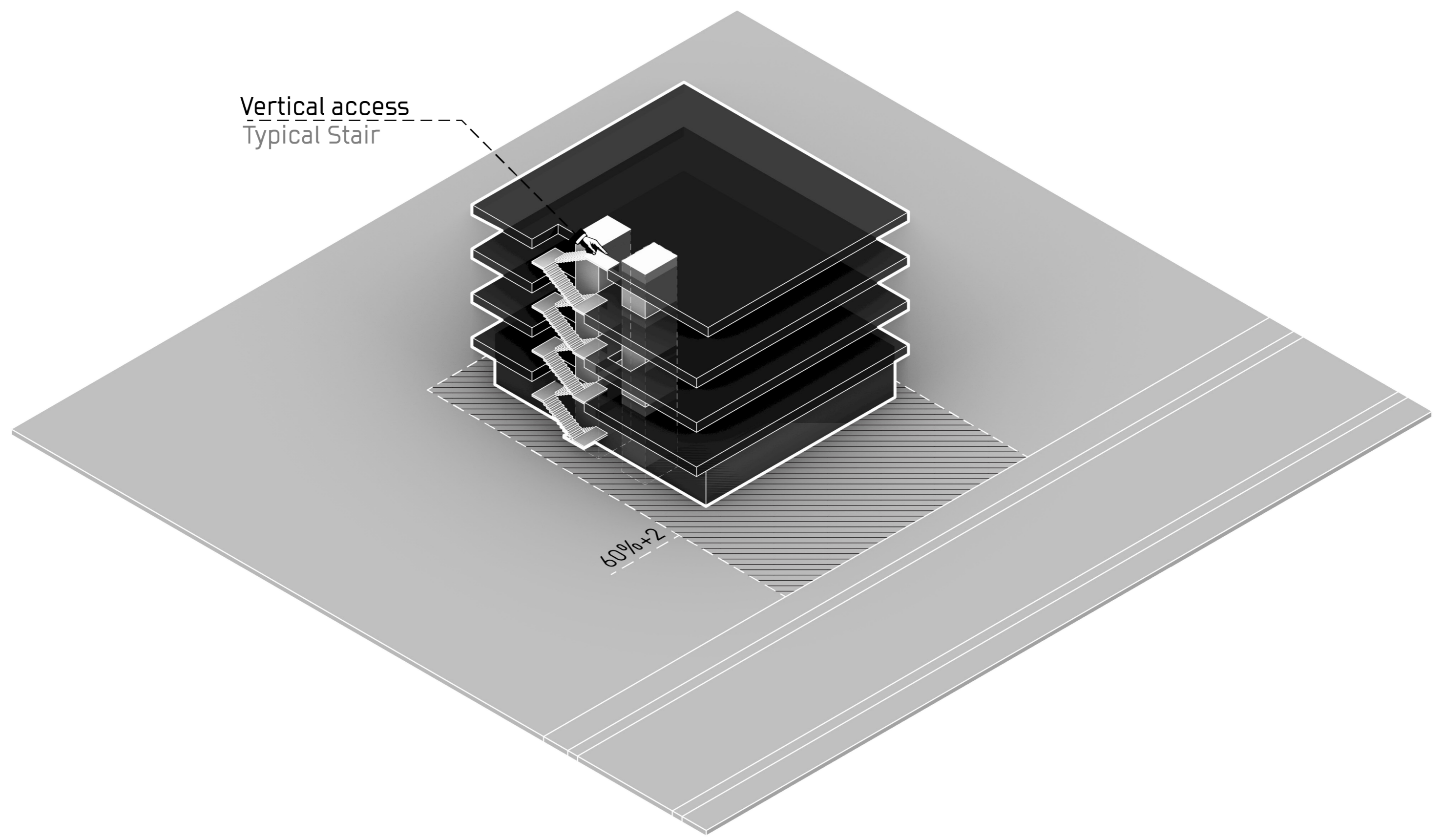

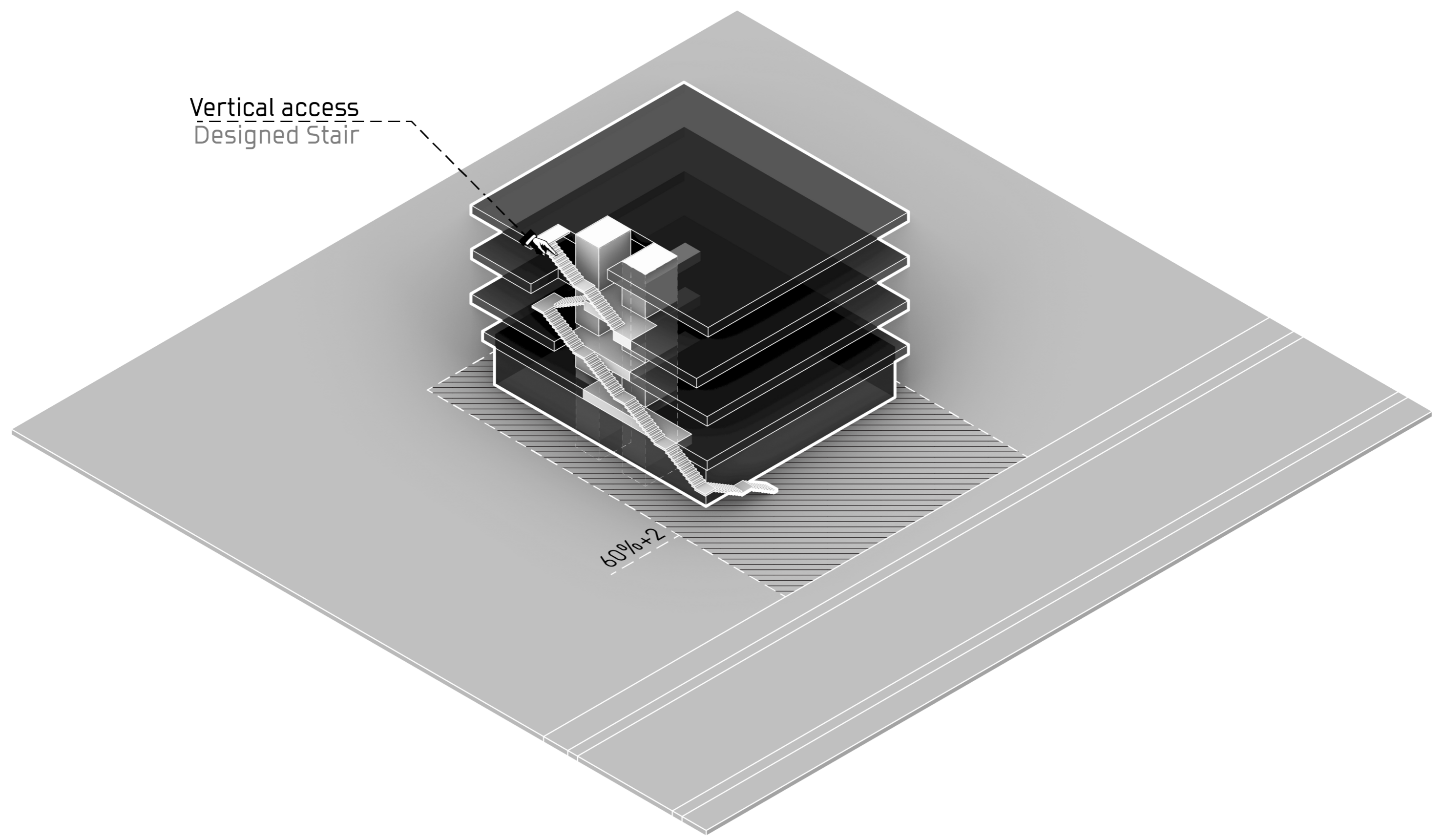

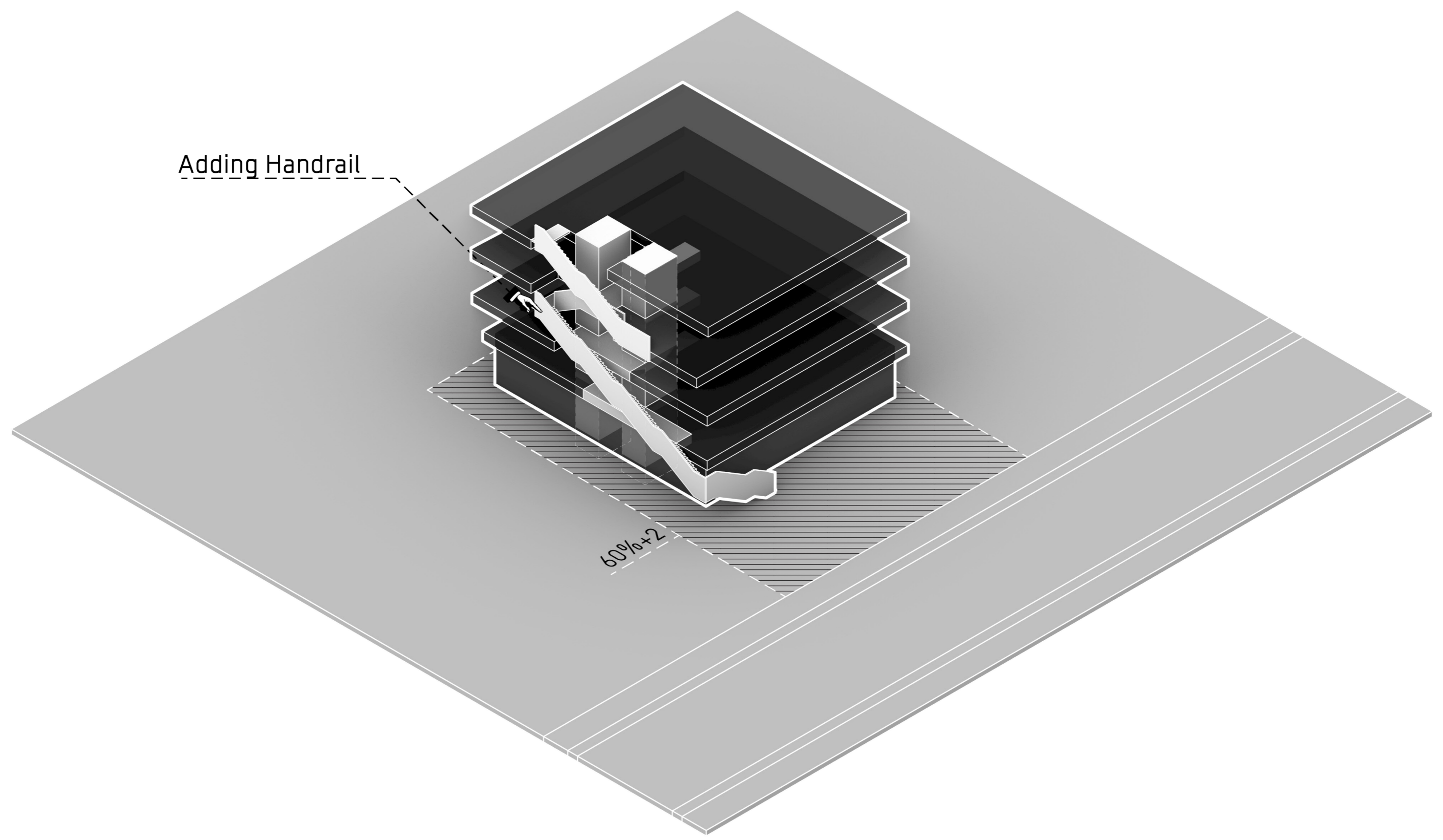

Adding Sloped Roof

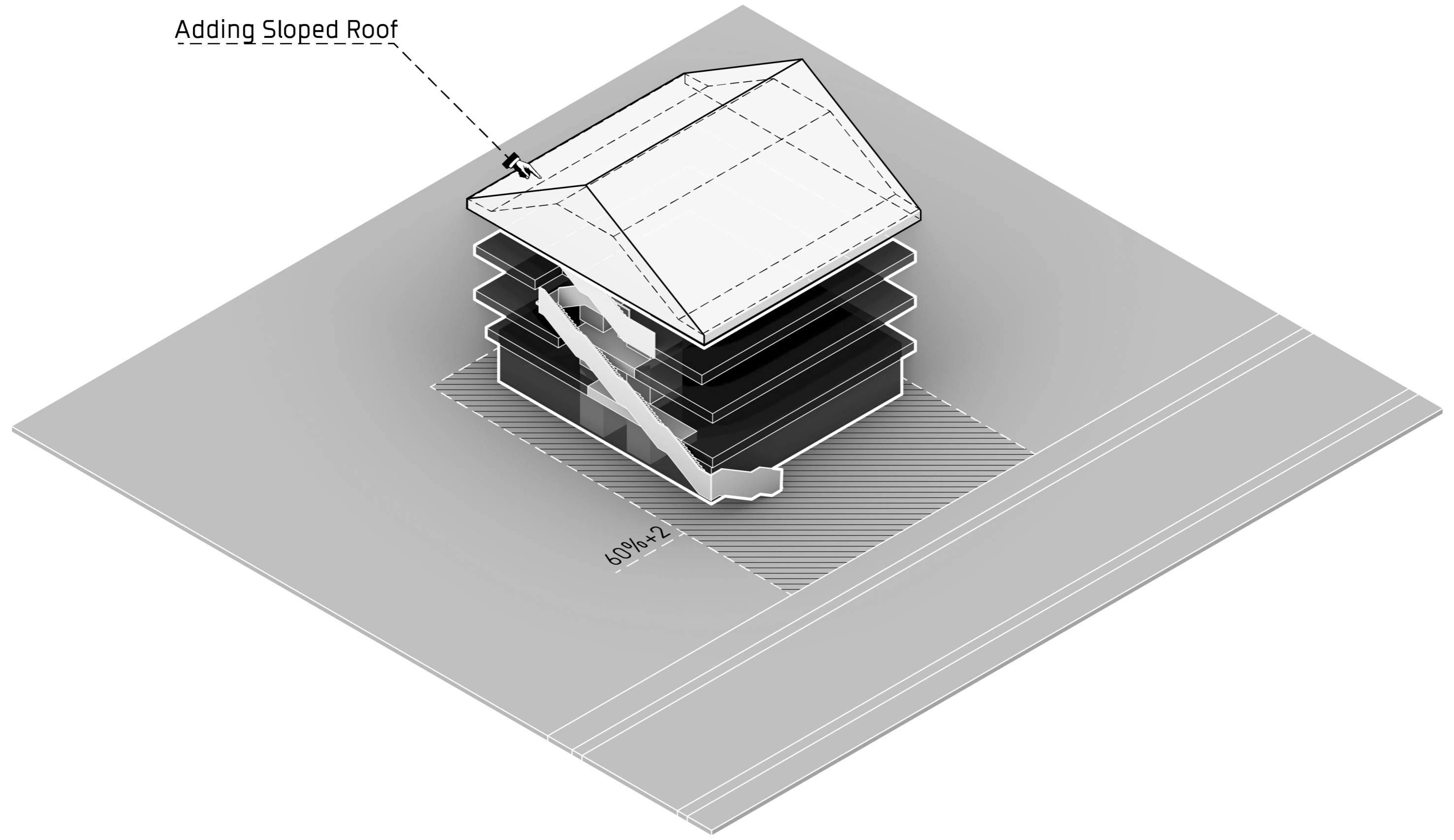

Terraced Stair Form

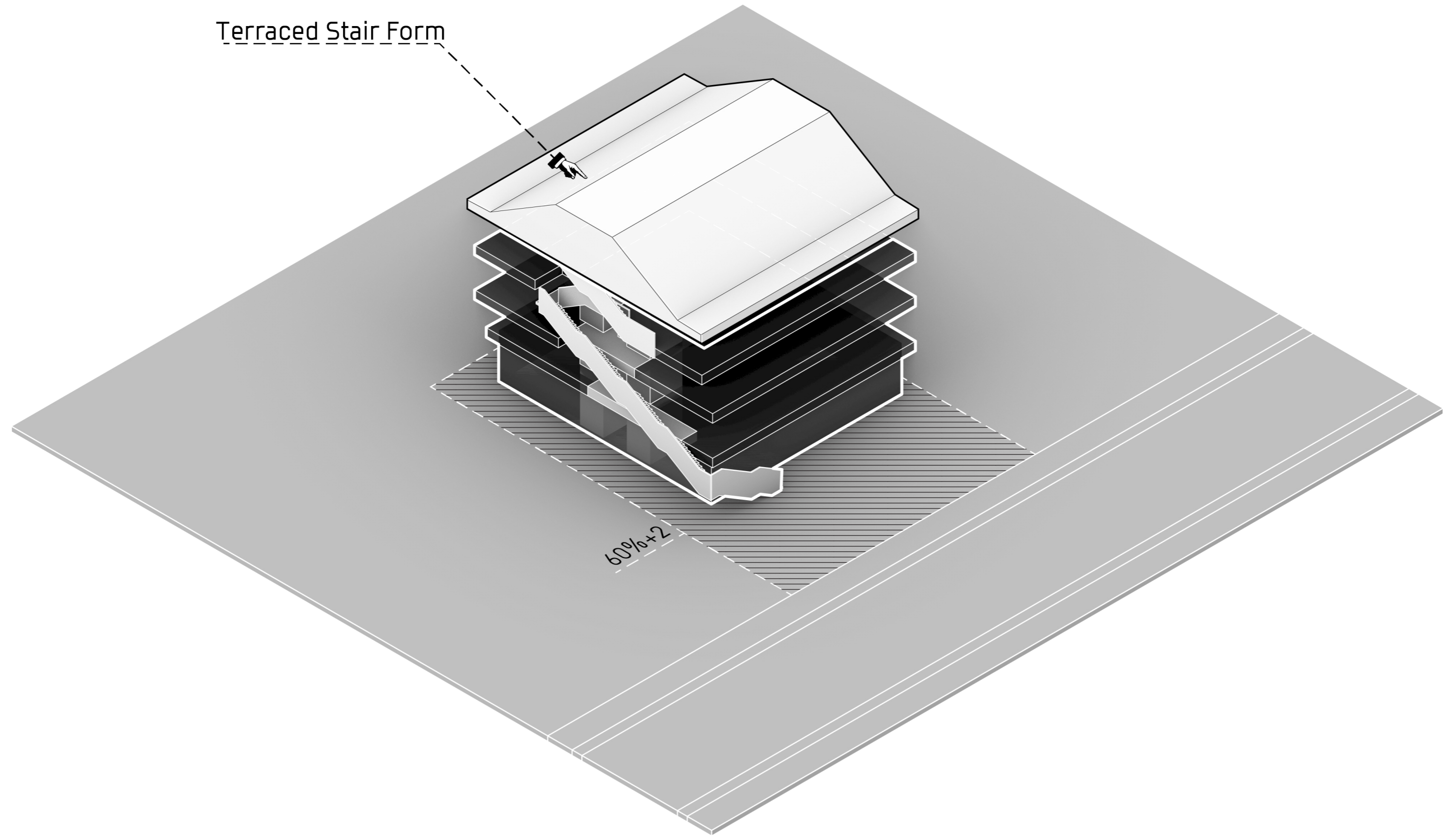

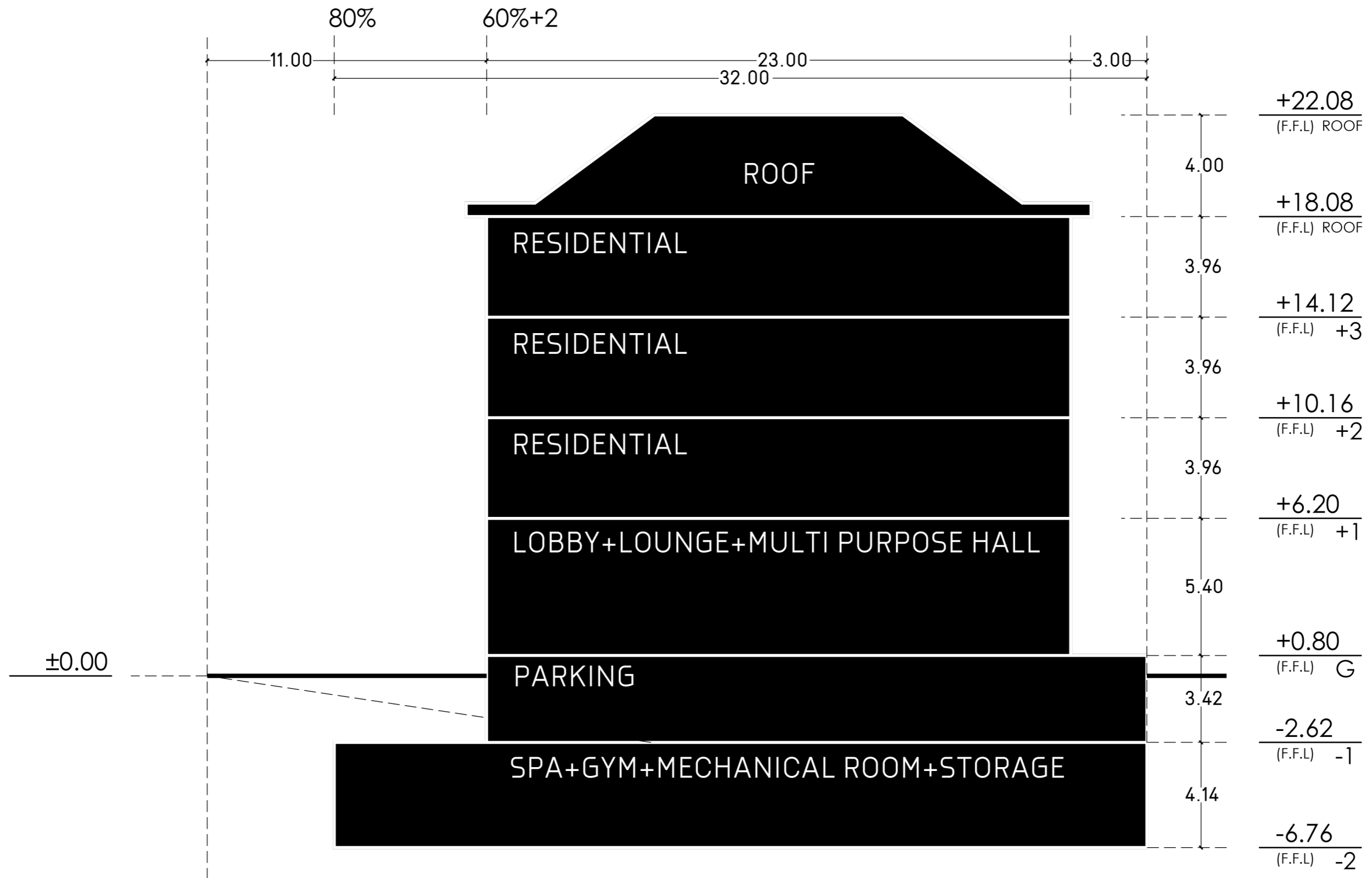

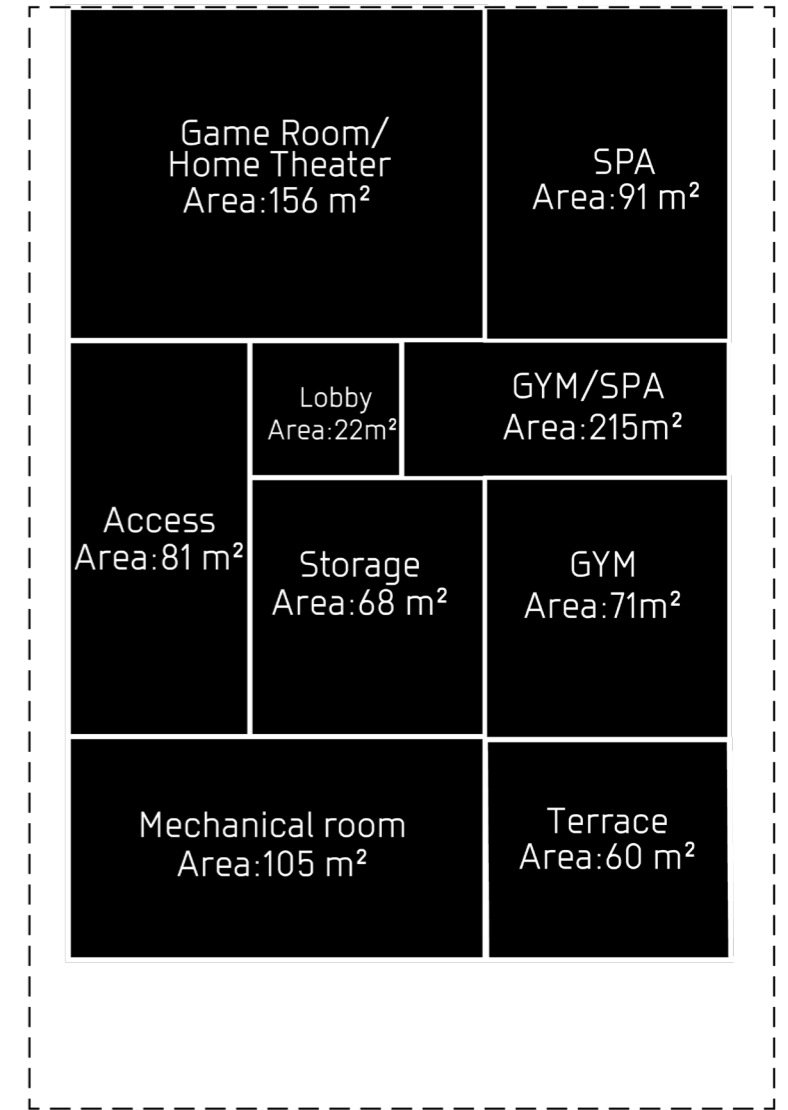
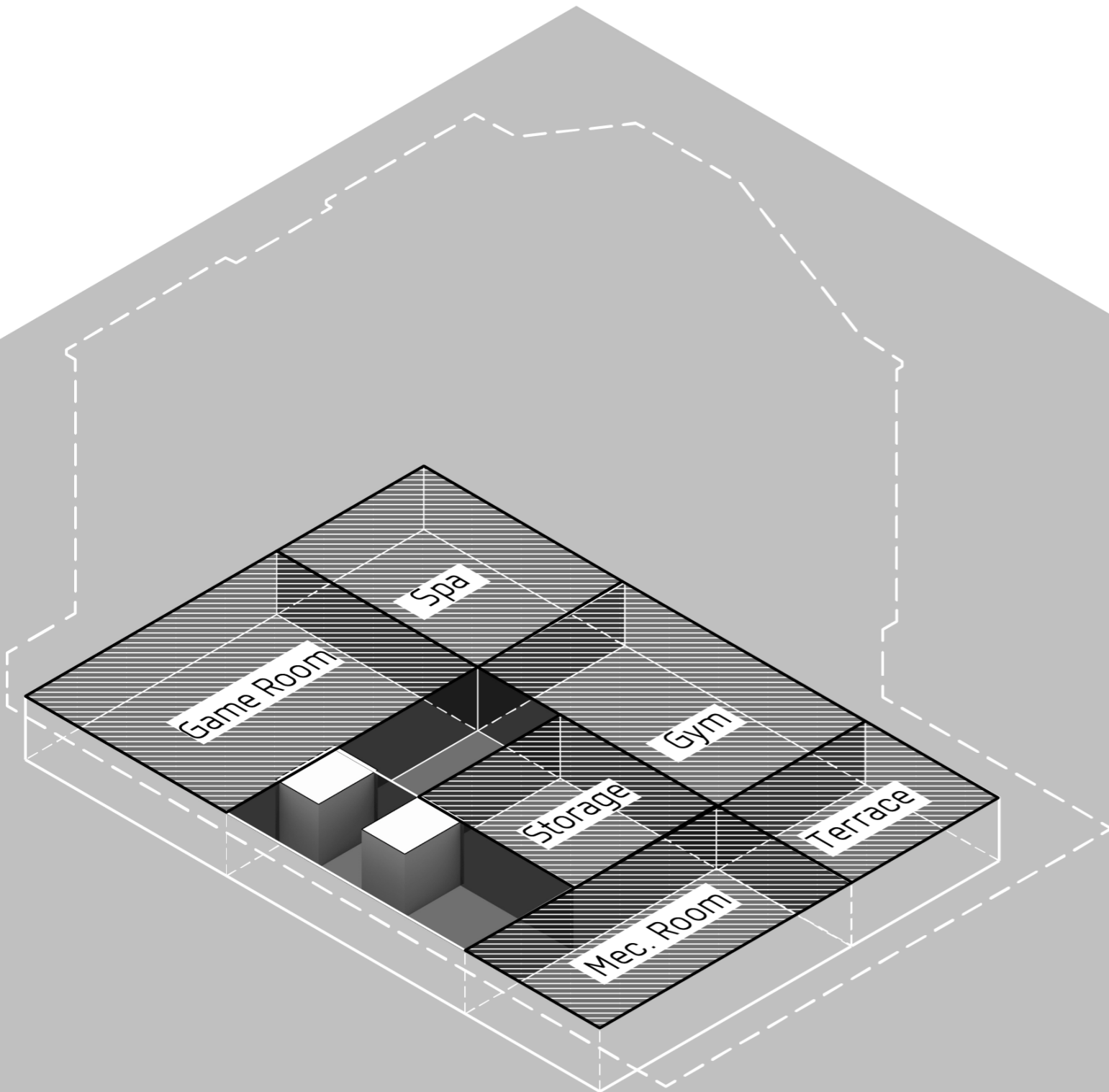

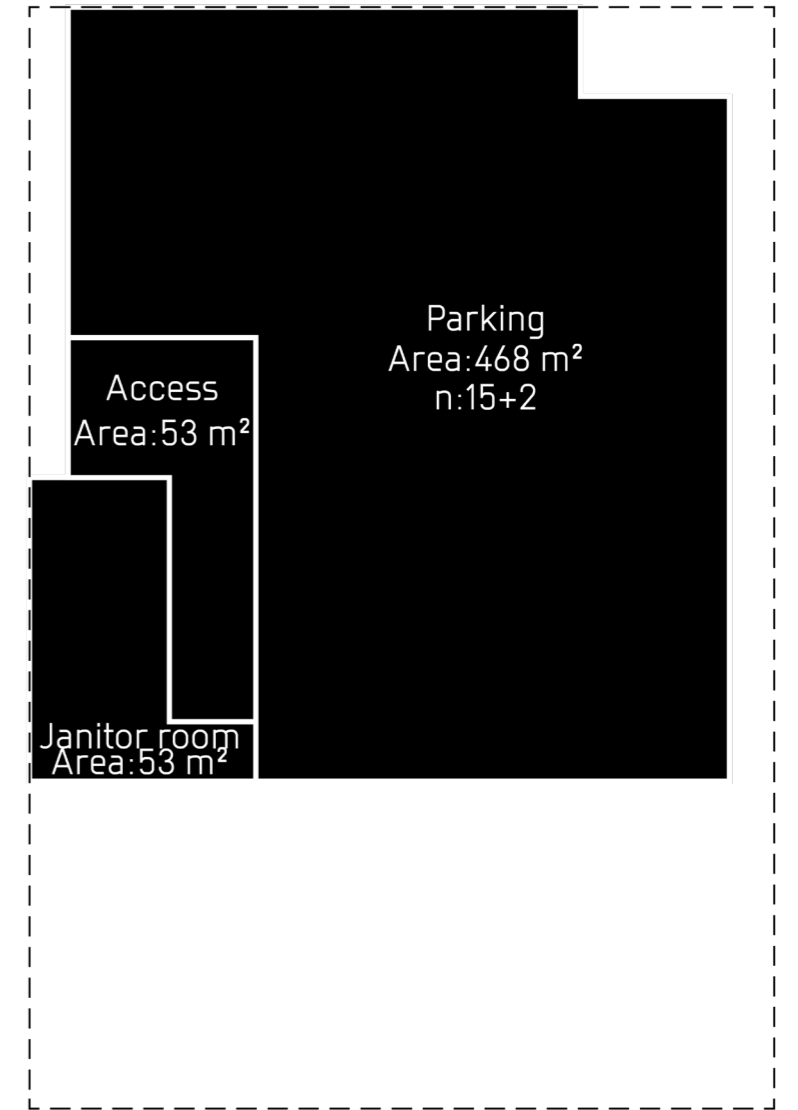
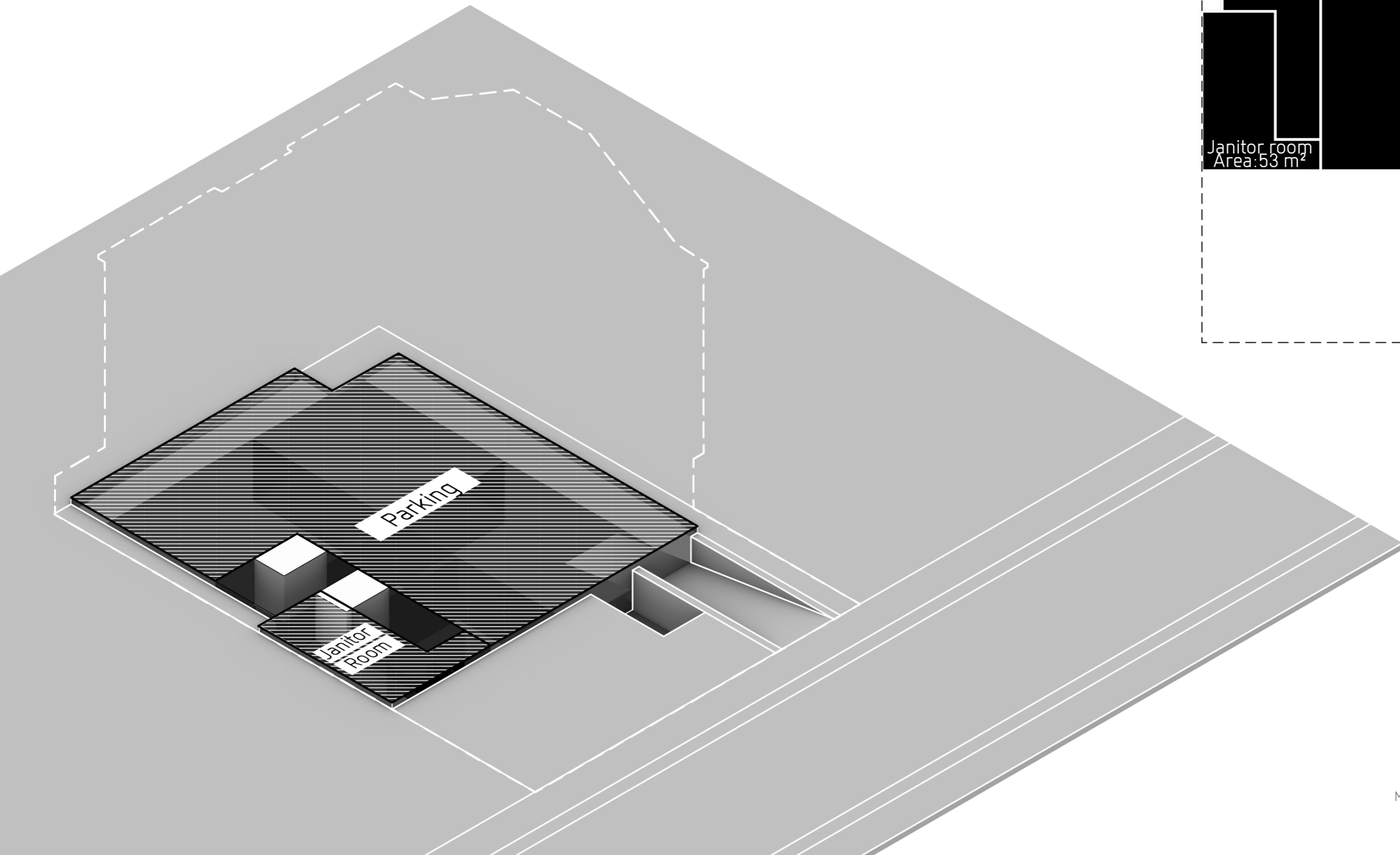

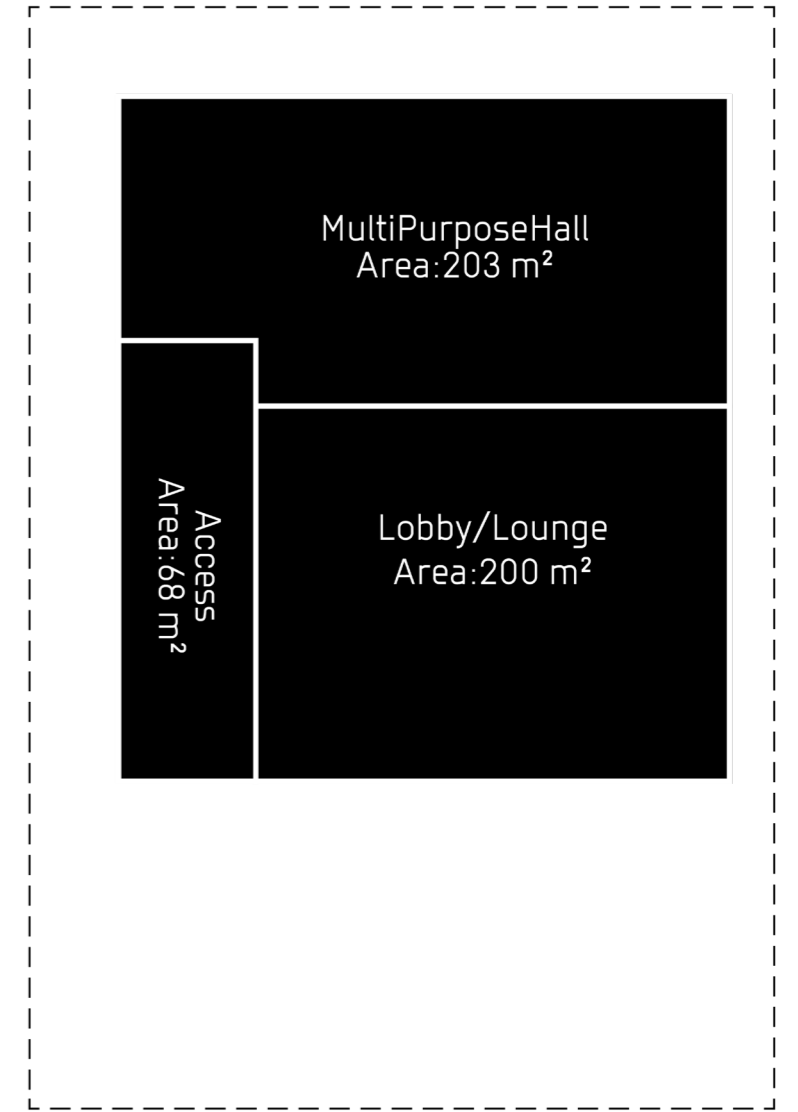
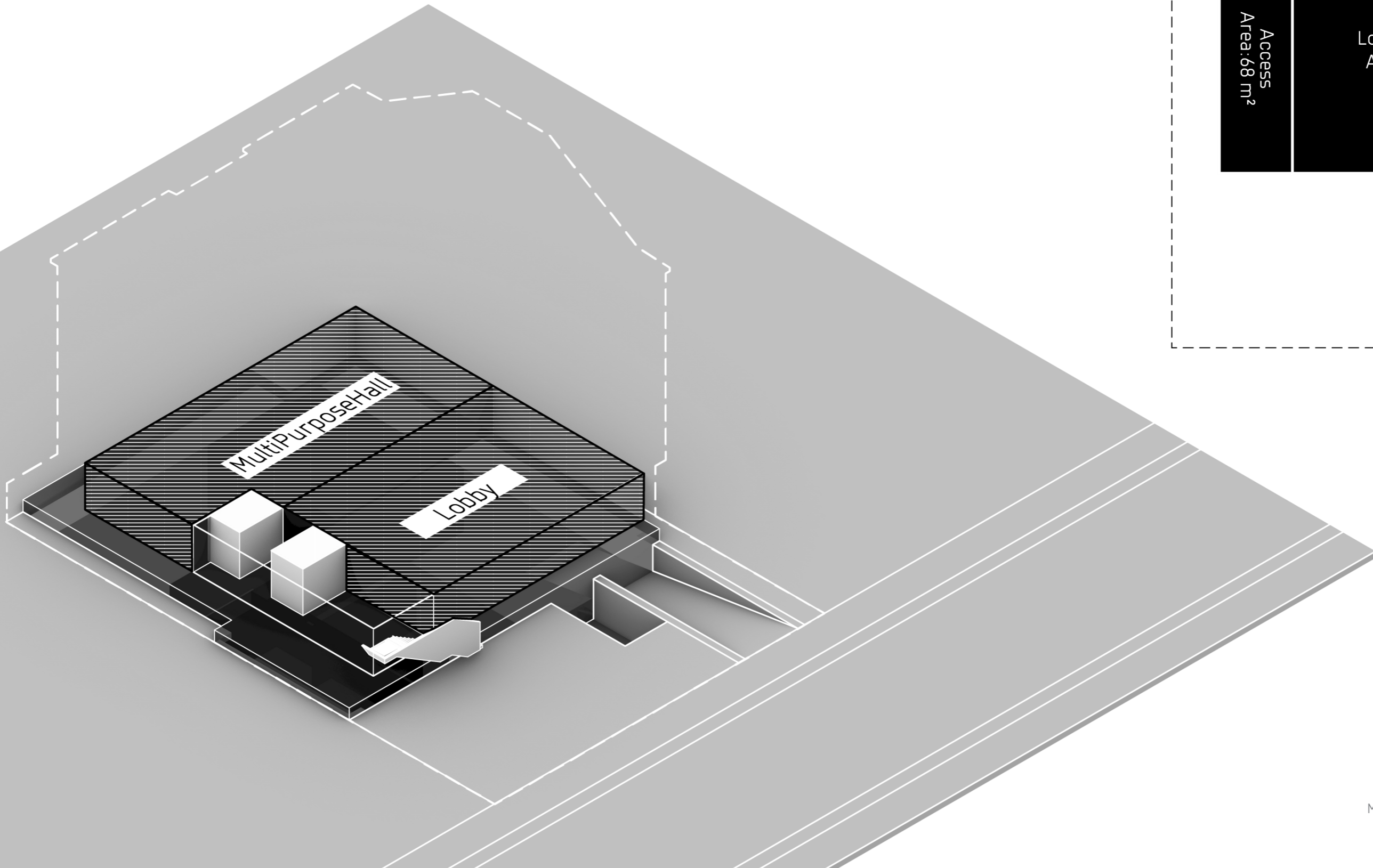

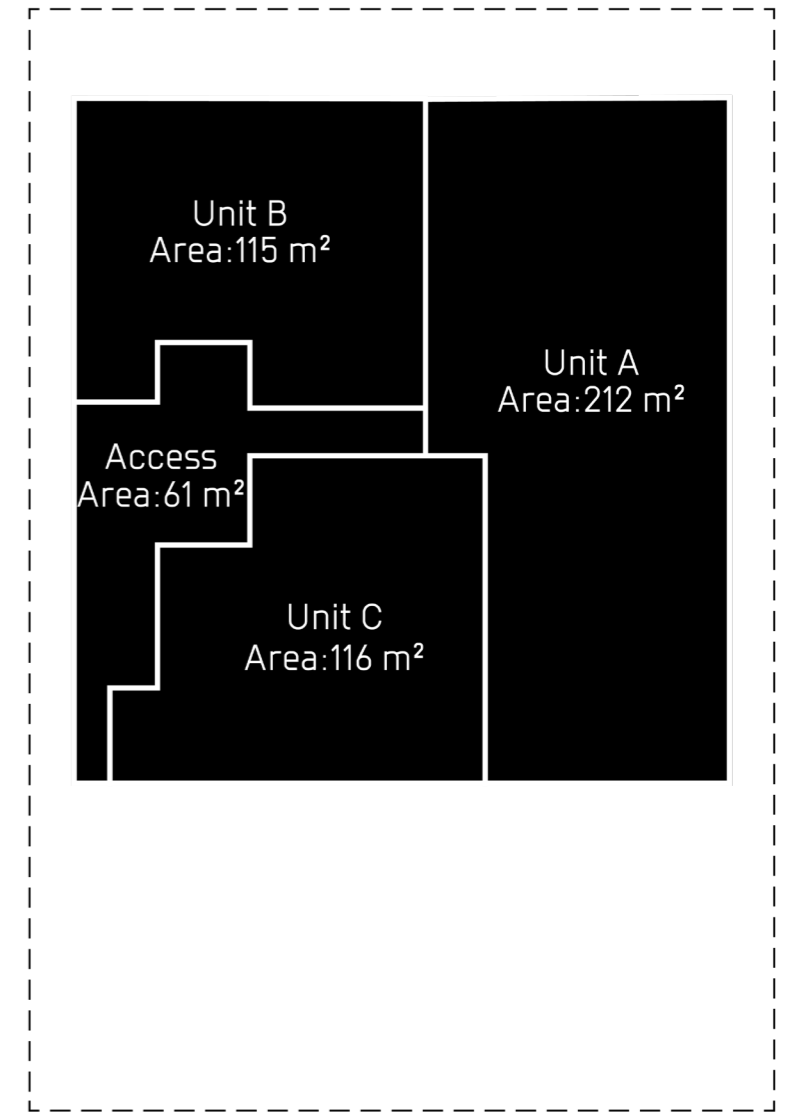
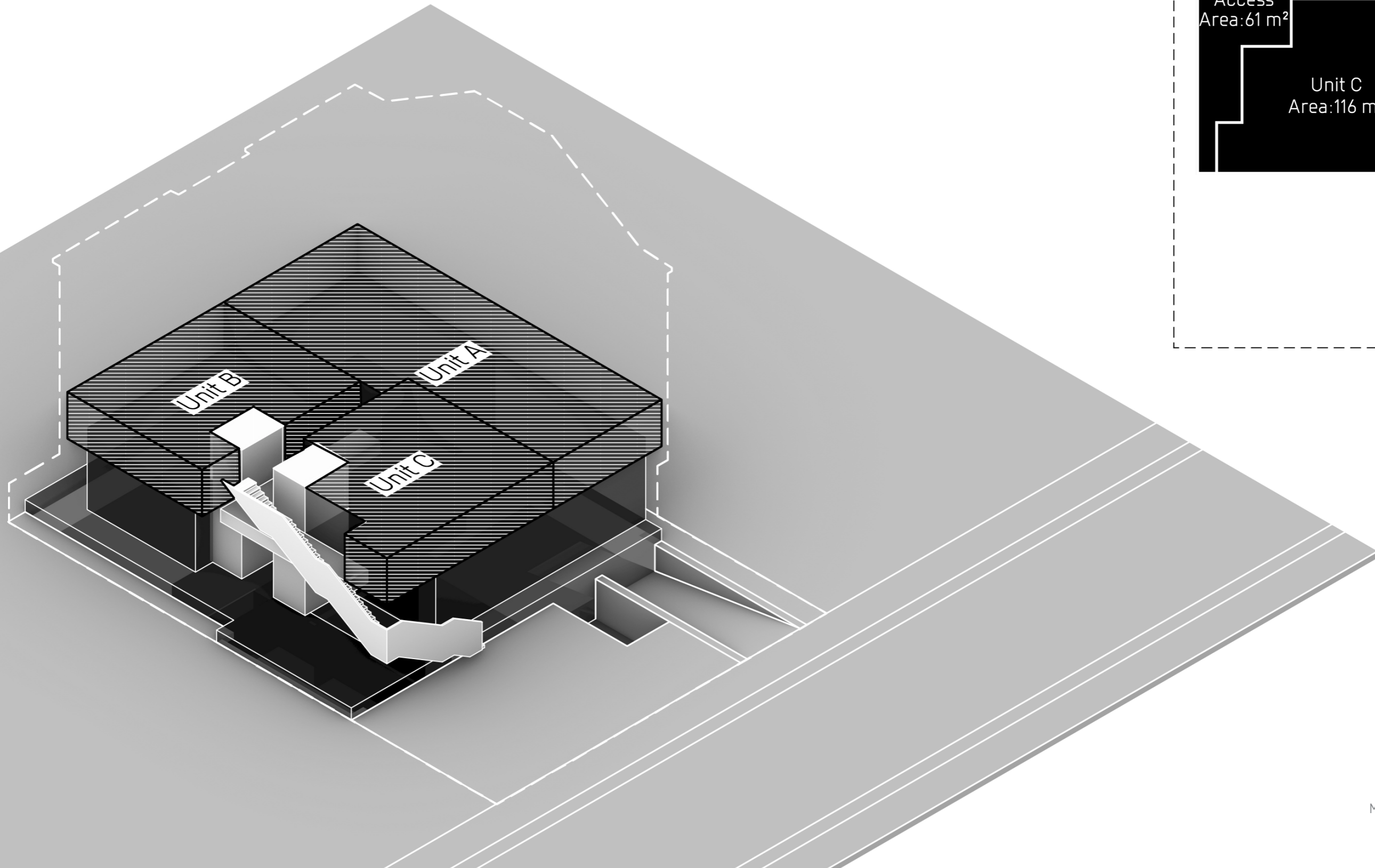

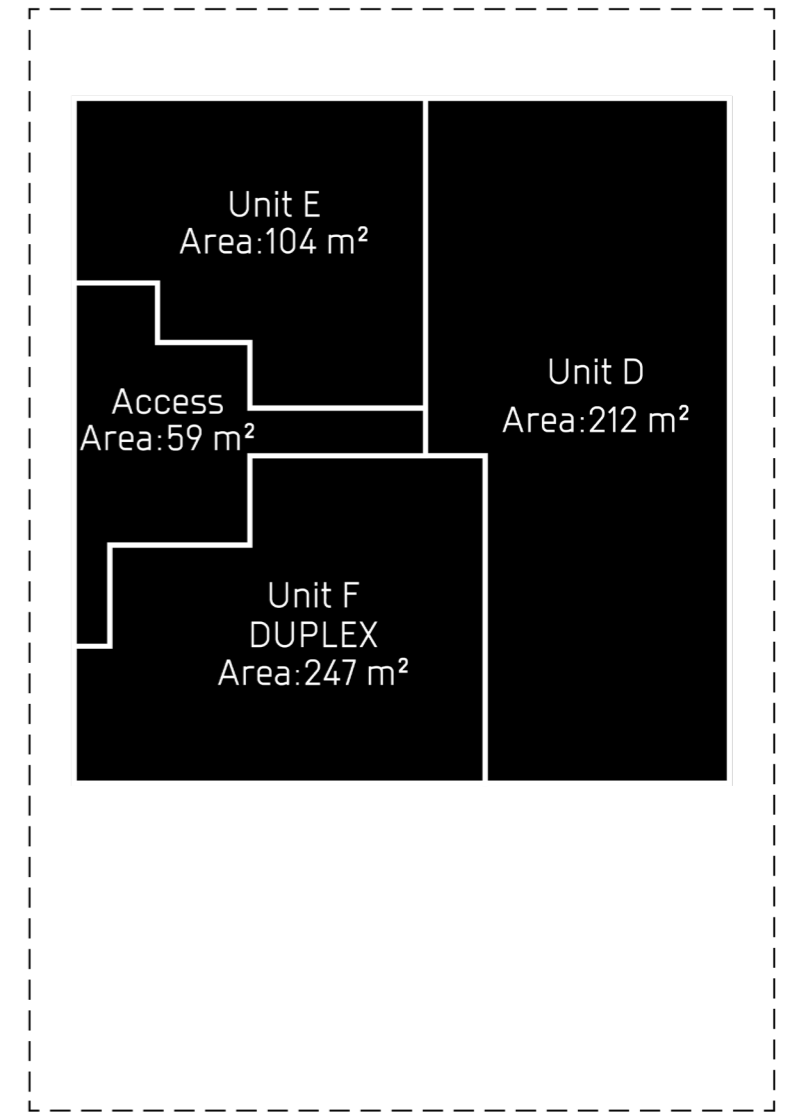
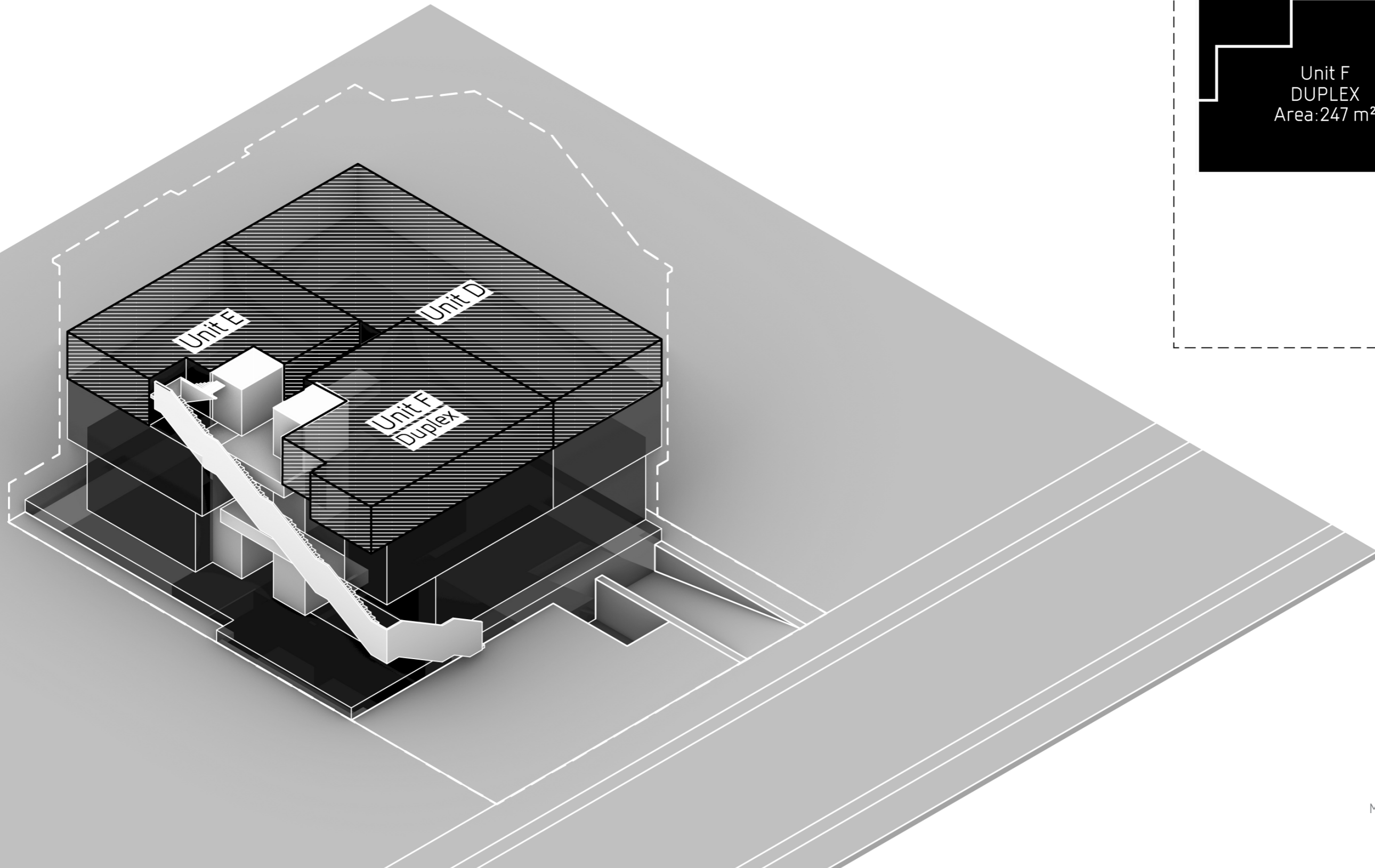

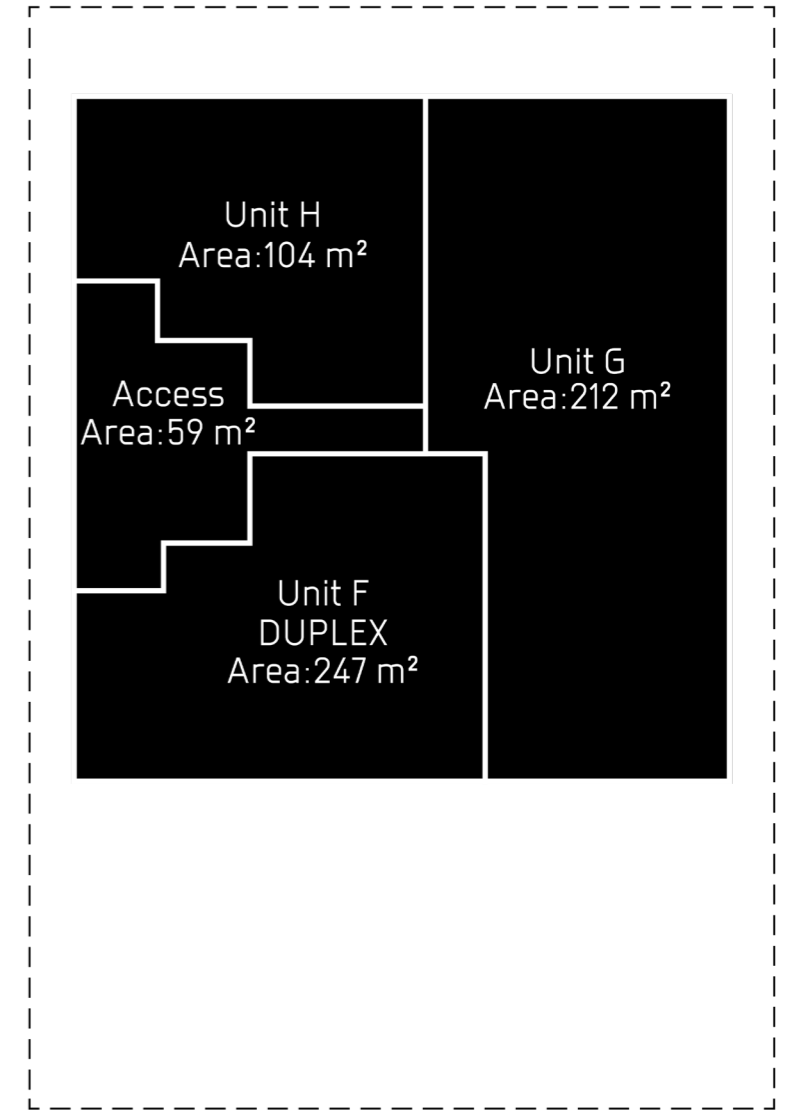
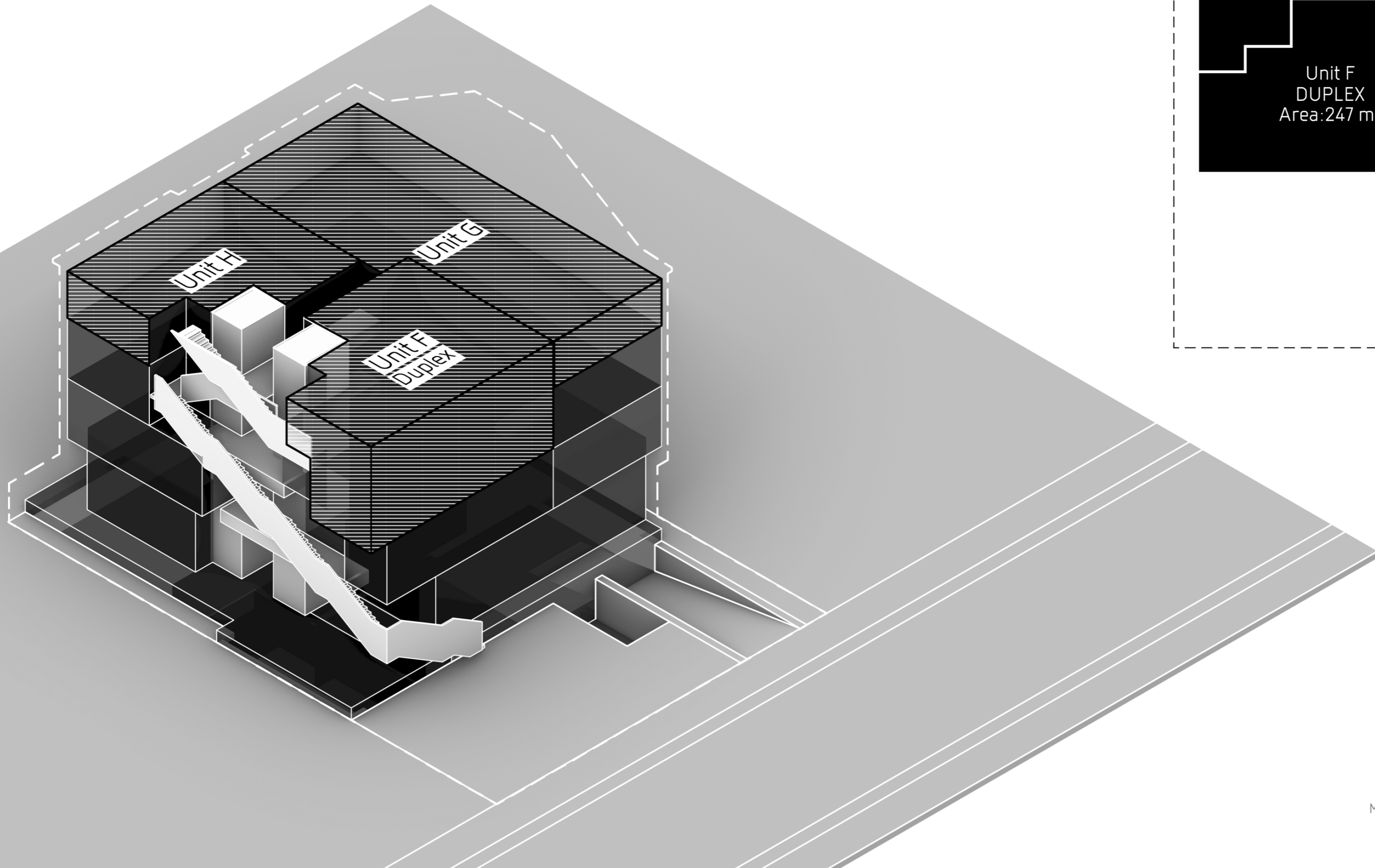

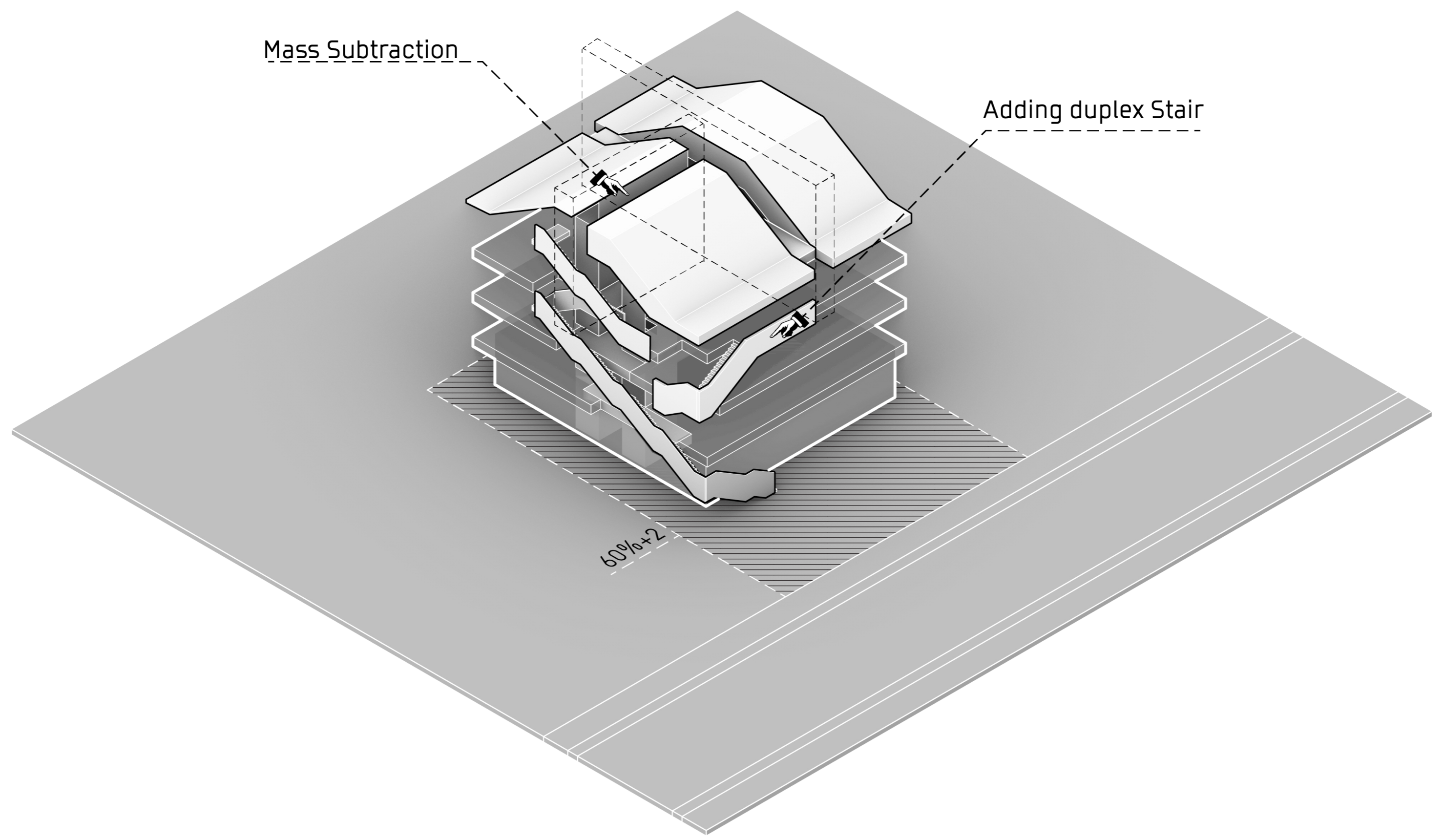

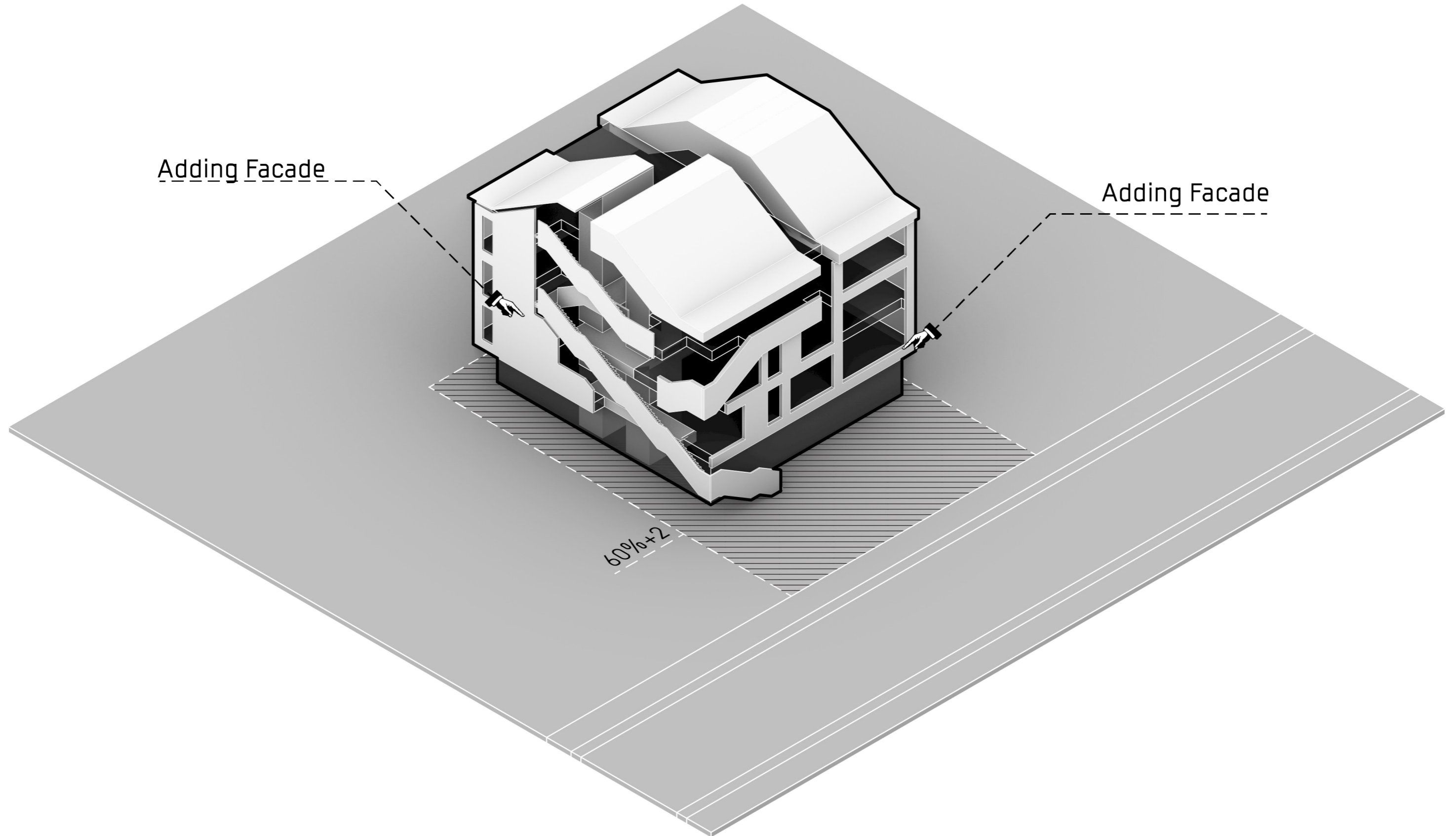

Done!

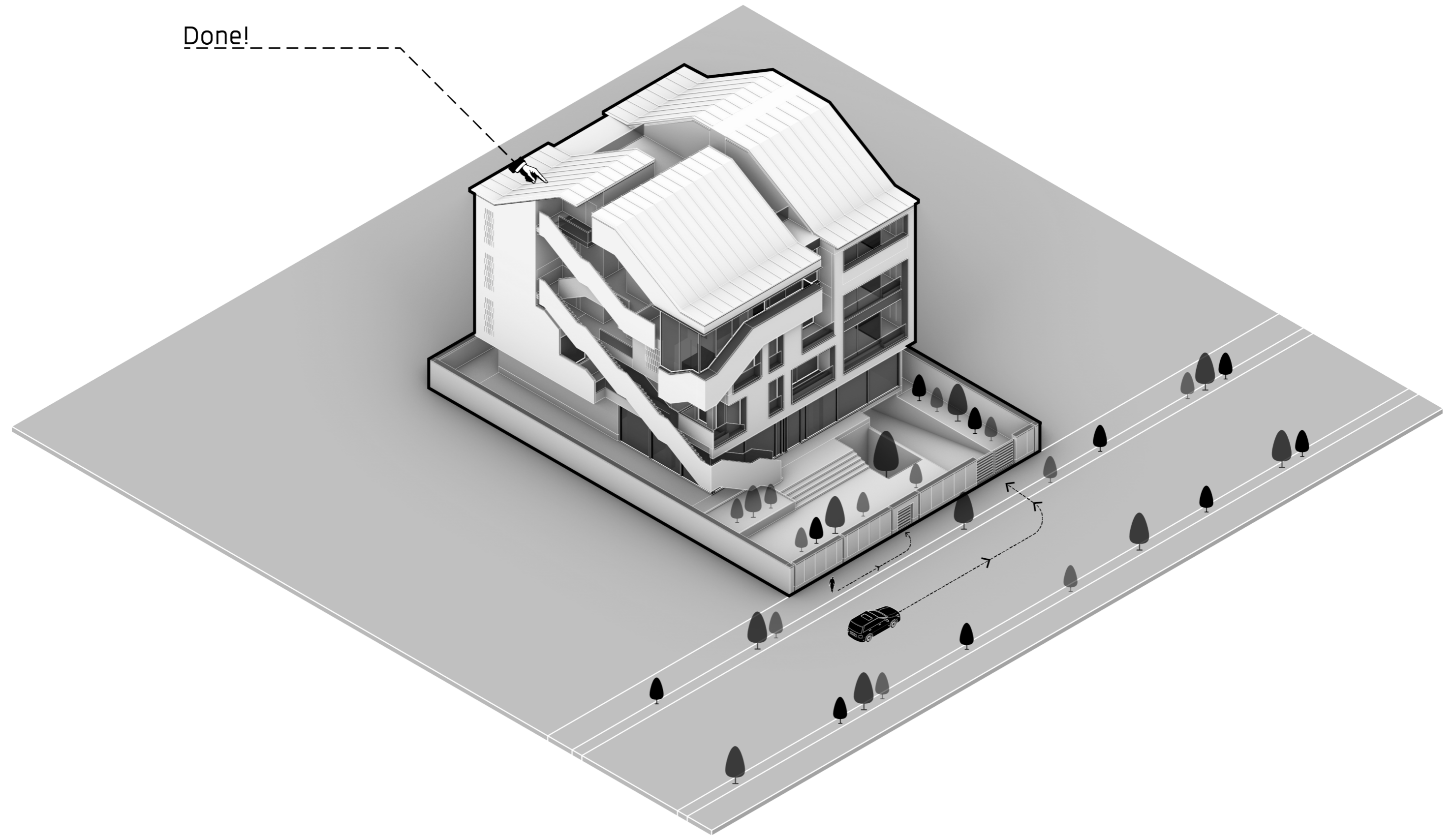

PLANS

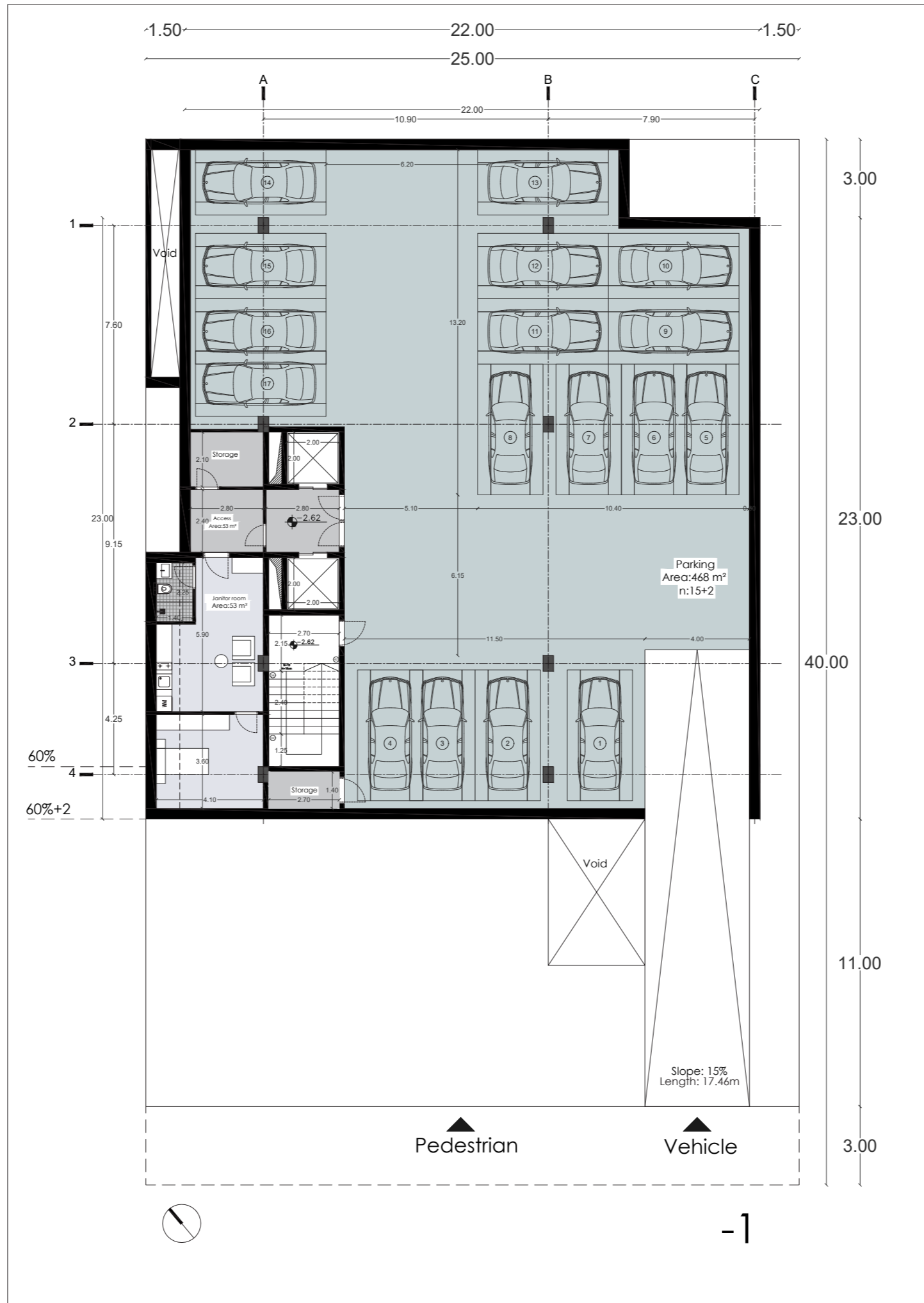

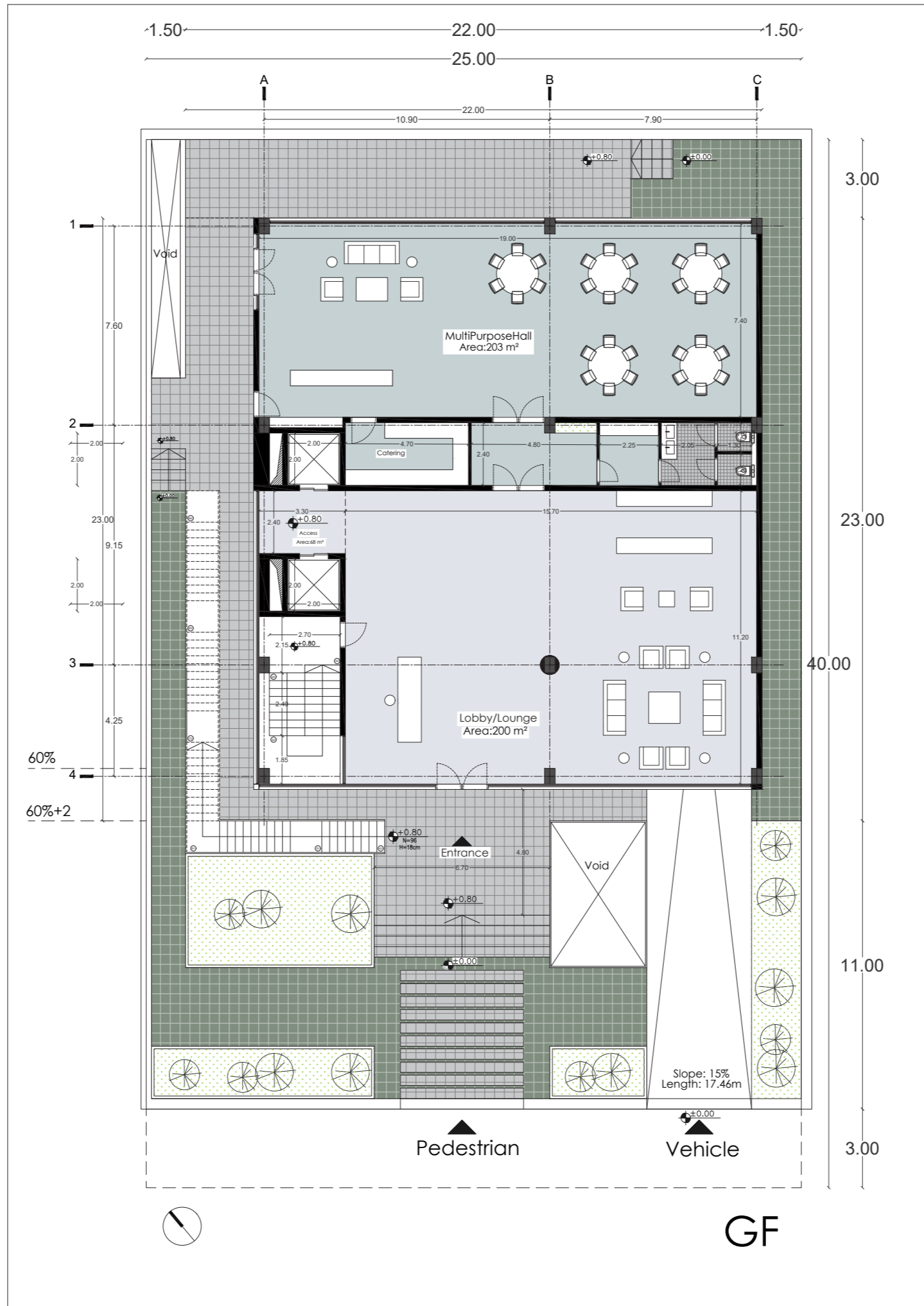

Plan
+1



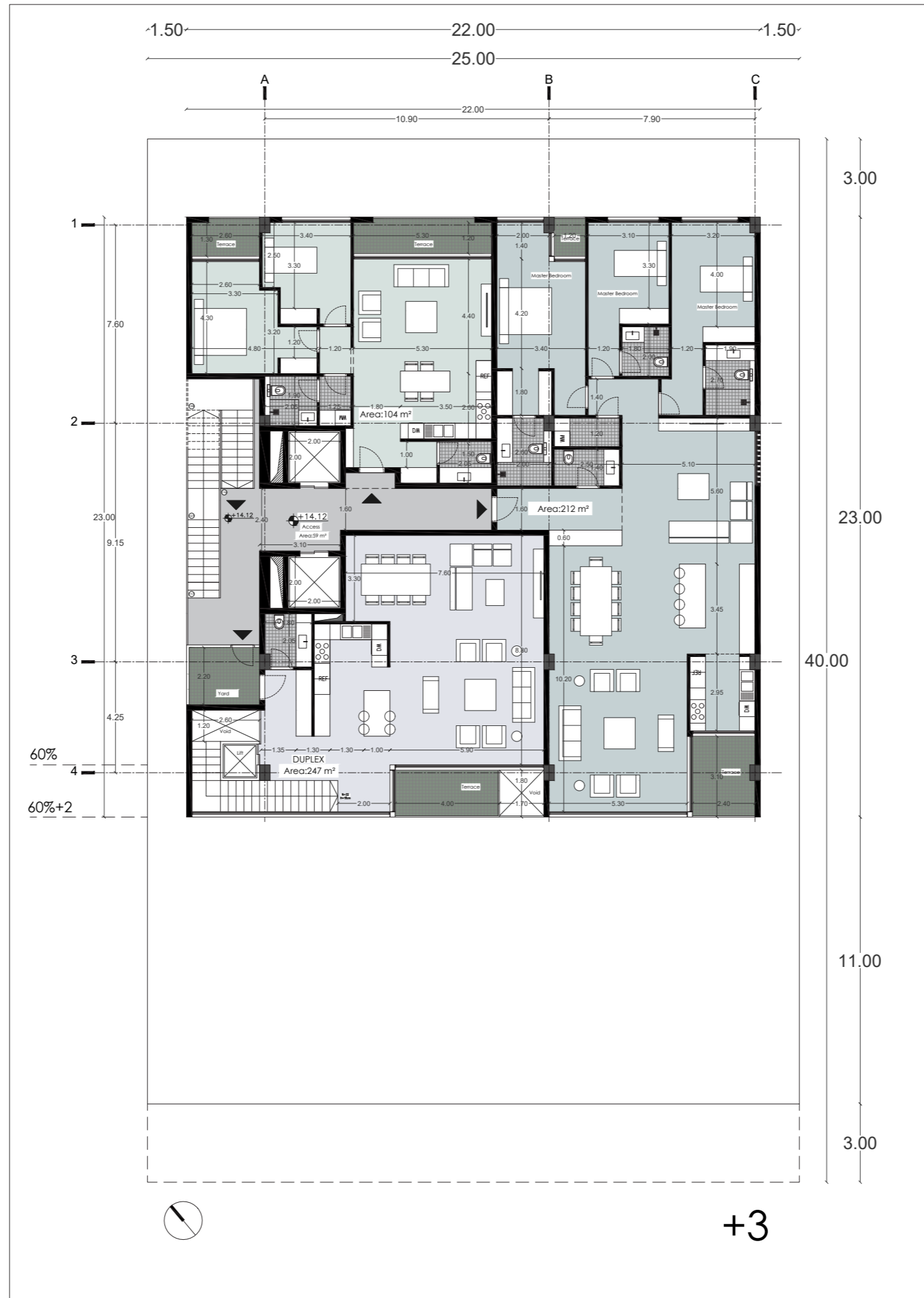

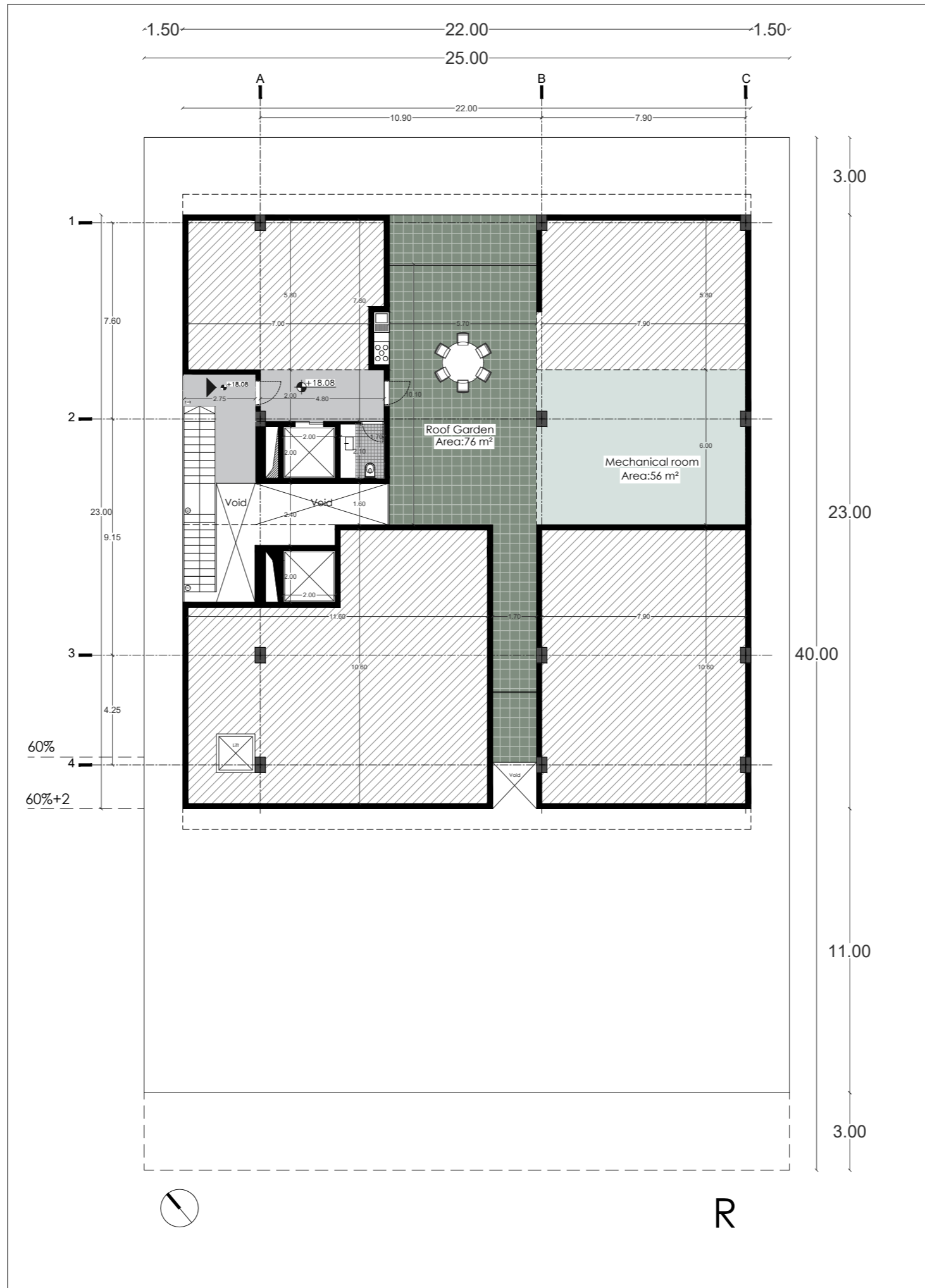

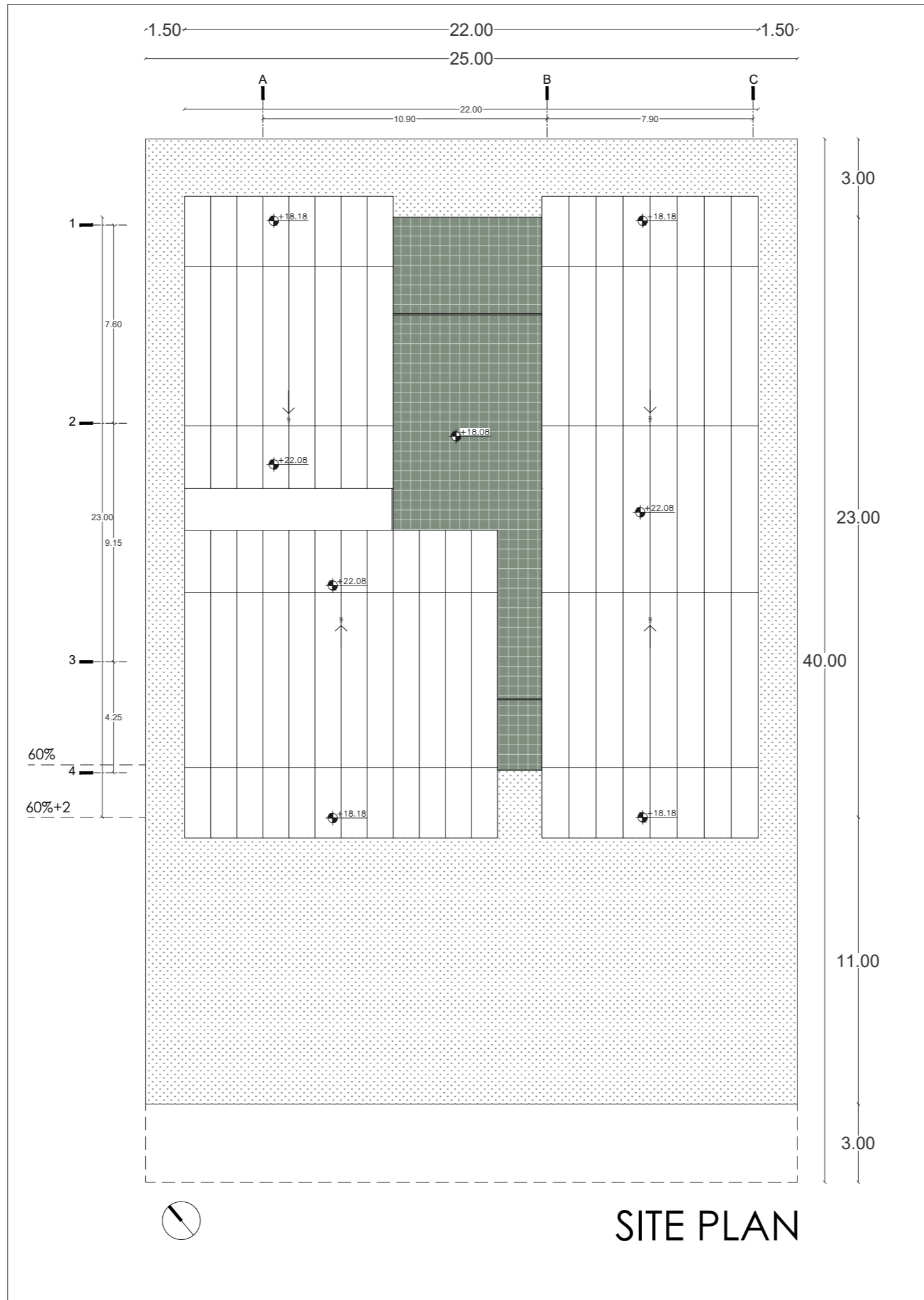

EXTERIOR VIEWS













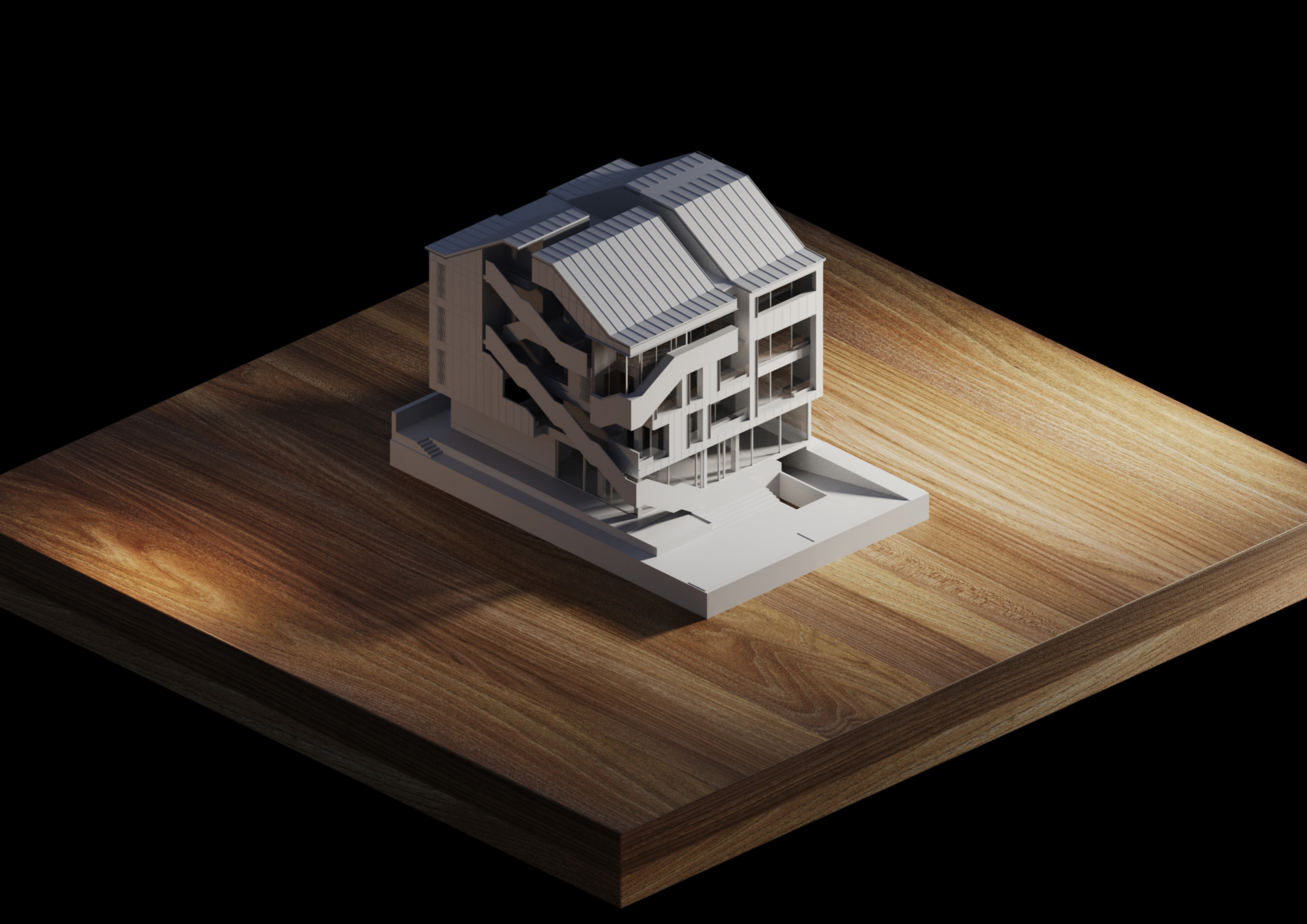



ZANDIGAN.COM